

# Manual Motor Starters

- Complete Ranges up to 100 Amps
- ON-OFF-Trip Three Position Operator
- Unique Handle Lock in the OFF Position
- Class 10, 20 Overload Trip Characteristics
- DIN Rail or Back Panel Mounting
- Finger Safe Terminals
- Trip Test



With  
Extended  
Warranty



# Carlo Gavazzi GMS Manual Motor Starters provide complete ranges up to 100A



## 32AF

0.1~0.16... 22~32A (16 step)

GMS 32S



Standard

GMS 32H  
GMS 32HI

High break  
Magnetic release

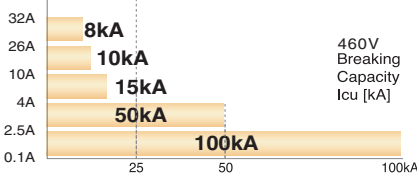

460V  
Breaking  
Capacity  
Icu [kA]

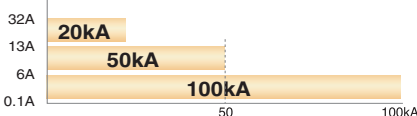

6~10... 45~63A (9 step)

GMS 63S



Standard

GMS 63H  
GMS 63HI  
GMS 63HL

High break  
Magnetic release  
Class 20

up to 100A

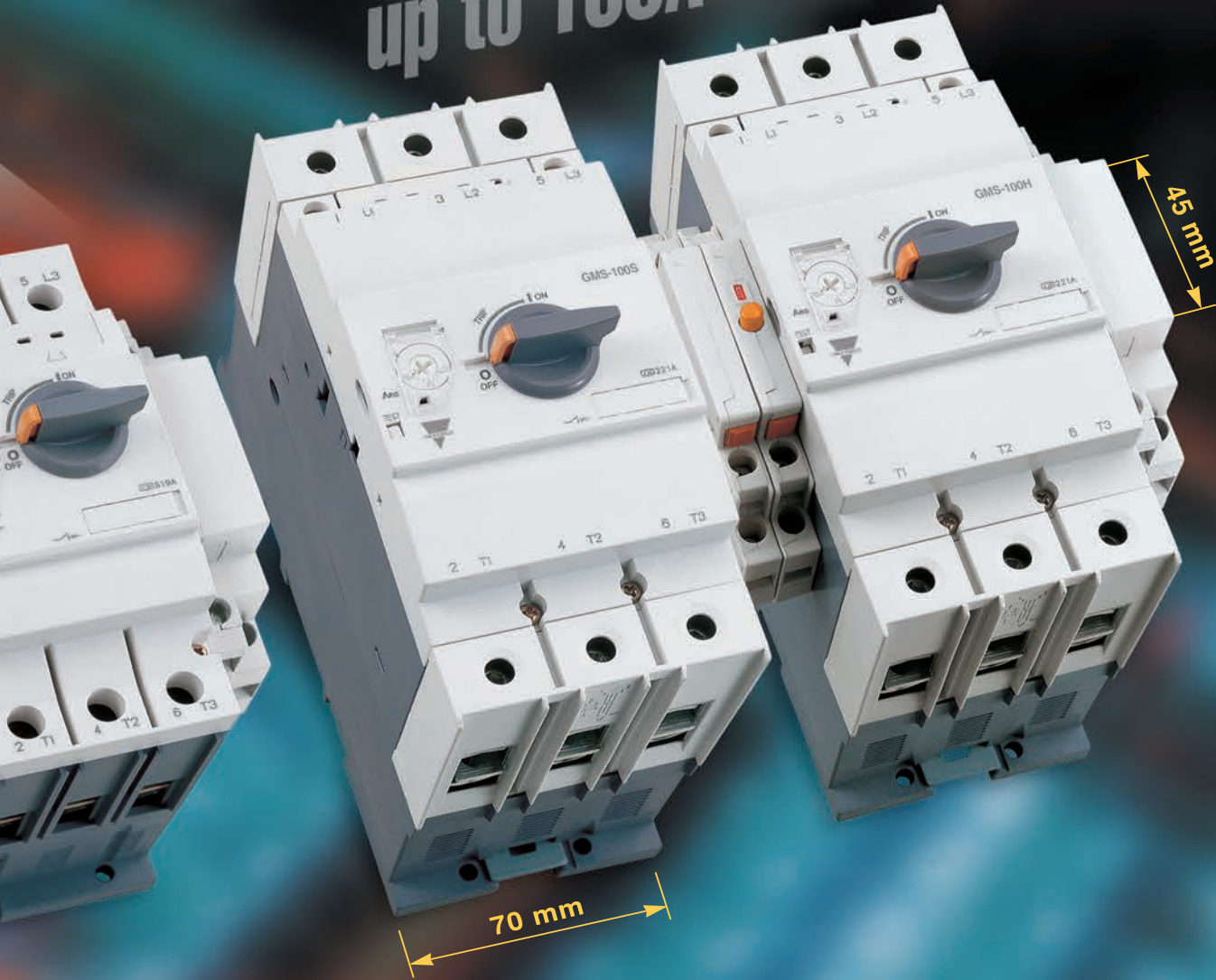

GMS

63AF

100AF

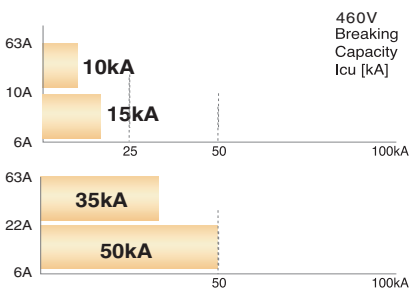

460V  
Breaking  
Capacity  
Icu [kA]

11~17... 80~100A (10 step)

GMS 100S

Standard

GMS 100H  
GMS 100HI  
GMS 100HL

- High break
- Magnetic release
- Class 20

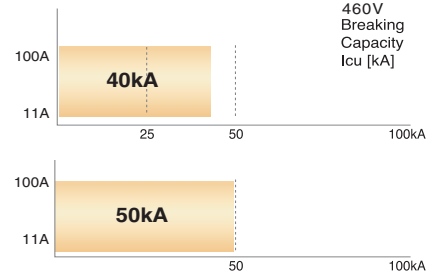

460V  
Breaking  
Capacity  
Icu [kA]

Specifications are subject to change without notice.

# Carlo Gavazzi GMS Manual Motor Starters deliver more efficiency through various functions and compact design

[ Scale 1:1 ]



## Handle Lock



## Dial cover



## Terminals



# Common use from 32 to 100AF



## A wide variety of accessories enables a flexible response to changes in specifications

### Accessories

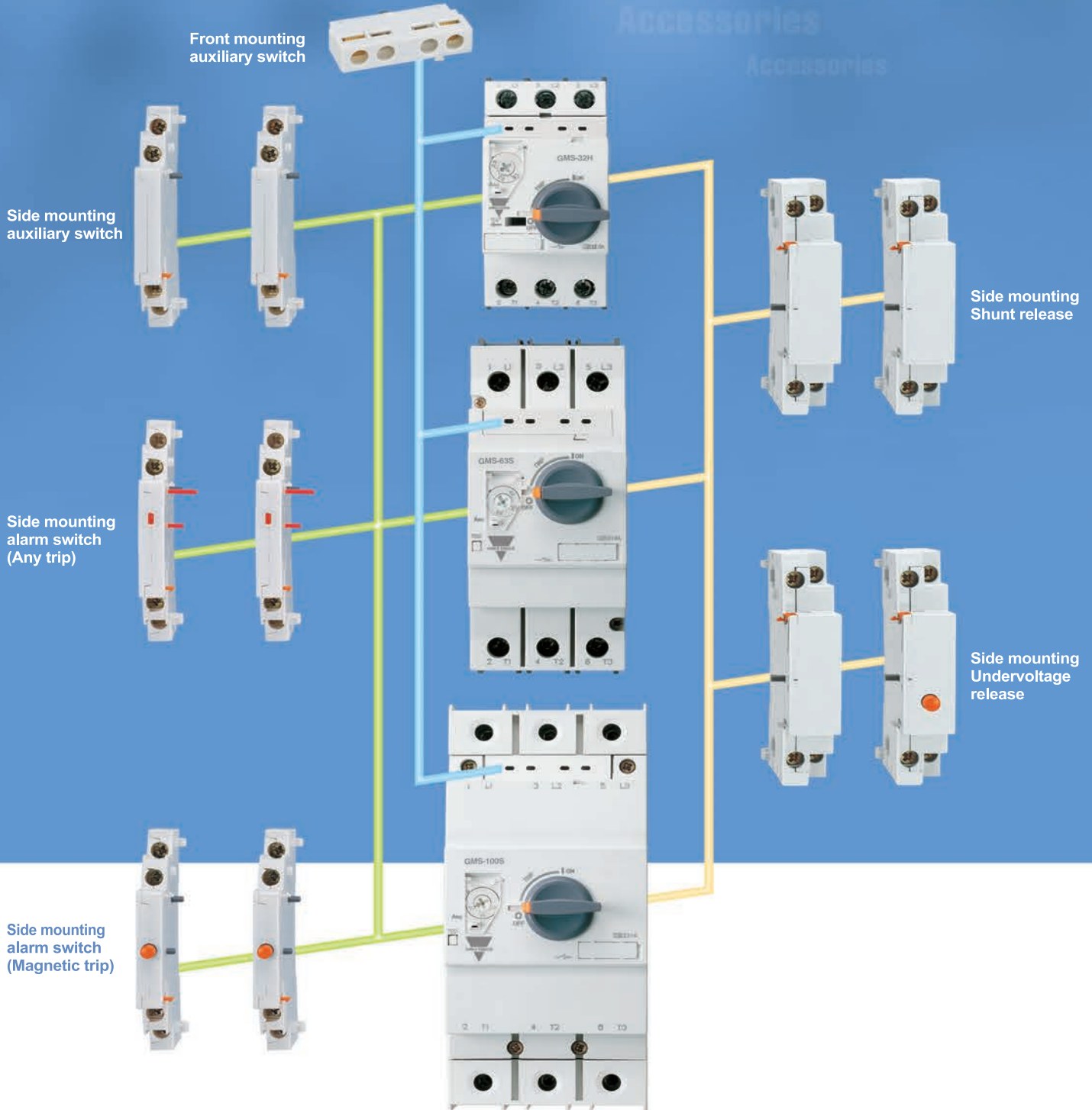

## Function

- Protection of group installation
- Protection of circuits
- Motor protection
- Starter protection
- Wide range of ambient temperature compensation
- Phase failure protection



## Feature

- 45mm width up to 32A, 55mm width up to 63A and 70mm width rated to 100 amps
- Three position operator: ON-OFF-TRIP (Only 100AF is applied)
- Complete range of common accessories
- Handle lock in the OFF position
- Class 10,20 overload trip characteristics
- Trip test
- Finger safe terminal
- DIN rail and screw mounting

## Standard

- The components fulfill the international standard IEC 60947
- The devices can be used as Manual Motor Starter in Group Installations According to UL508.



**KEMA**



**IEC 60947**

**UL 508, UL 508 Type E**

# Contents

## Product Selection Guide

Quick selection table ...IEC rating .....	8
Motor protection .....	10
Short-circuit protection for starters .....	12
Accessories .....	14
Busbar Accessories .....	16

## Technical Information

IEC performance data (motor protection).....	18
IEC performance data (Short-circuit protection for starters)	21
IEC Performance data (Motor protection: Class 20) .....	22
UL/CSA performance data (Motor protection) .....	23
Manual Motor Controller (UL508) .....	26
General data .....	28
Type 'Z' coordination according to IEC 947-4-1 .....	32
Time/Current characteristic .....	33
Dimensions .....	34



# Product Selection Guide

## Quick selection table ... IEC rating



Frame			32AF																			
Type	Current adjustable type		GMS-32S					GMS-32H					GMS-32HI									
	Instantaneous type		-					-					-									
Class 20			-					-					-									
Breaking capacity			Standard					High break					High break									
Handle Type			Rocker					Rocker					Rotary									
Number of poles			3					3					3									
Rated operational voltage (Ue)			Up to 690V					Up to 690V					Up to 690V									
Rated frequency			50/60 Hz					50/60 Hz					50/60 Hz									
Rated insulation voltage (Ui)			690V					690V					690V									
Rated impulse voltage (Uimp)			6kV					6kV					6kV									
Utilization category			IEC 60 947-2 (Breaker )					Cat. A					Cat. A									
			IEC 60 947-4 (Motor starter)					AC 3					AC 3									
Shock resistance (IEC 68 Part 2-27)			25g					25g					25g									
Degree of protection (IEC 60 529)			IP 20					IP 20					IP 20									
Instantaneous short circuit release			13 × I <sub>e</sub> max.					13 × I <sub>e</sub> max.					13 × I <sub>e</sub> max.									
Mechanical endurance (Operating)			100,000					100,000					100,000									
Electrical endurance (Cycles)			100,000					100,000					100,000									
Max operating frequency per hour (Ope./h)			25					25					25									
Temperature compensation (Operation)			-20 ~ +60 °C					-20 ~ +60 °C					-20 ~ +60 °C									
Phase failure function			○					○					○									
Trip indicating function			×					×					×									
Test function			○					○					○									
Rated breaking capacity (kA)	Rated operational current (I <sub>e</sub> )	Thermal release Adjustment range (A)	240V		415V		460V		525V		690V		240V		415V		460V		525V		690V	
			230V	400V	440V	500V	600V	230V	400V	440V	500V	600V	230V	400V	440V	500V	600V					
			I <sub>cu</sub>	I <sub>cs</sub>	I <sub>cu</sub>	I <sub>cs</sub>	I <sub>cu</sub>	I <sub>cs</sub>	I <sub>cu</sub>	I <sub>cs</sub>	I <sub>cu</sub>	I <sub>cs</sub>	I <sub>cu</sub>	I <sub>cs</sub>	I <sub>cu</sub>	I <sub>cs</sub>	I <sub>cu</sub>	I <sub>cs</sub>	I <sub>cu</sub>	I <sub>cs</sub>	I <sub>cu</sub>	I <sub>cs</sub>
	0.16	0.1~0.16	100	100	100	100	100	100	100	100	100	100	100	100	100	100	100	100	100	100	100	100
	0.25	0.16~0.25	100	100	100	100	100	100	100	100	100	100	100	100	100	100	100	100	100	100	100	100
	0.4	0.25~0.4	100	100	100	100	100	100	100	100	100	100	100	100	100	100	100	100	100	100	100	100
	0.63	0.4~0.63	100	100	100	100	100	100	100	100	100	100	100	100	100	100	100	100	100	100	100	100
	1	0.63~1	100	100	100	100	100	100	100	100	100	100	100	100	100	100	100	100	100	100	100	100
	1.6	1~1.6	100	100	100	100	100	100	100	100	3	3	100	100	100	100	100	100	100	100	100	100
	2.5	1.6~2.5	100	100	100	100	100	100	50	38	3	3	100	100	100	100	100	100	100	100	8	8
	4	2.5~4	100	100	100	100	50	38	15	11	3	3	100	100	100	100	100	100	100	100	8	8
	6	4~6	100	100	100	100	15	11	10	8	3	3	100	100	100	100	100	100	100	100	6	6
	8	5~8	100	100	100	100	15	11	10	8	3	3	100	100	100	100	50	38	50	38	6	6
	10	6~10	100	100	50	38	15	11	6	5	3	3	100	100	100	100	50	38	50	38	6	6
	13	9~13	100	100	50	38	10	8	6	5	3	3	100	100	100	100	50	38	42	32	6	6
	17	11~17	50	38	20	15	10	8	6	5	3	3	100	100	50	38	20	15	10	8	4	4
	22	14~22	40	30	15	11	8	6	6	5	3	3	100	100	50	38	20	15	10	8	4	4
	26	18~26	40	30	15	11	8	6	6	5	3	3	100	100	50	38	20	15	10	8	4	4
	32	22~32	30	22	15	11	6	4	5	4	3	3	100	100	50	38	20	15	10	8	4	4
	40	28~40	-	-	-	-	-	-	-	-	-	-	-	-	-	-	-	-	-	-	-	-
	50	34~50	-	-	-	-	-	-	-	-	-	-	-	-	-	-	-	-	-	-	-	-
	63	45~63	-	-	-	-	-	-	-	-	-	-	-	-	-	-	-	-	-	-	-	-
	75	55~75	-	-	-	-	-	-	-	-	-	-	-	-	-	-	-	-	-	-	-	-
	90	70~90	-	-	-	-	-	-	-	-	-	-	-	-	-	-	-	-	-	-	-	-
	100	80~100	-	-	-	-	-	-	-	-	-	-	-	-	-	-	-	-	-	-	-	-

### Ordering Example: Specify Rated Operational Current

GMS-32S-0.16 (0.1 to 0.16)

GMS-32S-0.25 (0.16 to 0.25)





63AF															100AF									
GMS-63S					GMS-63H										GMS-100S					GMS-100H				
-					GMS-63HI										-					GMS-100HI				
-					GMS-63HL										-					GMS-100HL				
Standard					High break										Standard					High break				
Rotary					Rotary										Rotary					Rotary				
3					3										3					3				
Up to 690V					Up to 690V										Up to 690V					Up to 690V				
50/60 Hz					50/60 Hz										50/60 Hz					50/60 Hz				
1,000V					1,000V										1,000V					1,000V				
8kV					8kV										8kV					8kV				
Cat. A					Cat. A										Cat. A					Cat. A				
AC 3					AC 3										AC 3					AC 3				
25g					25g										25g					25g				
IP 20					IP 20										IP 20					IP 20				
13 × I <sub>e</sub> max.					13 × I <sub>e</sub> max.										13 × I <sub>e</sub> max.					13 × I <sub>e</sub> max.				
50,000					50,000										50,000					50,000				
25,000					25,000										25,000					25,000				
25					25										25					25				
-20 ~ +60 °C					-20 ~ +60 °C										-20 ~ +60 °C					-20 ~ +60 °C				
○					○										○					○				
×					×										○					○				
○					○										○					○				
240V	415V	460V	525V	690V	240V	415V	460V	525V	690V	240V	415V	460V	525V	690V	240V	415V	460V	525V	690V					
230V	400V	440V	500V	600V	230V	400V	440V	500V	600V	230V	400V	440V	500V	600V	230V	400V	440V	500V	600V					
I <sub>cu</sub>	I <sub>cs</sub>	I <sub>cu</sub>	I <sub>cs</sub>	I <sub>cu</sub>	I <sub>cs</sub>	I <sub>cu</sub>	I <sub>cs</sub>	I <sub>cu</sub>	I <sub>cs</sub>	I <sub>cu</sub>	I <sub>cs</sub>	I <sub>cu</sub>	I <sub>cs</sub>	I <sub>cu</sub>	I <sub>cs</sub>	I <sub>cu</sub>	I <sub>cs</sub>	I <sub>cu</sub>	I <sub>cs</sub>	I <sub>cu</sub>	I <sub>cs</sub>			
-	-	-	-	-	-	-	-	-	-	-	-	-	-	-	-	-	-	-	-	-	-	-		
-	-	-	-	-	-	-	-	-	-	-	-	-	-	-	-	-	-	-	-	-	-	-		
-	-	-	-	-	-	-	-	-	-	-	-	-	-	-	-	-	-	-	-	-	-	-		
-	-	-	-	-	-	-	-	-	-	-	-	-	-	-	-	-	-	-	-	-	-	-		
-	-	-	-	-	-	-	-	-	-	-	-	-	-	-	-	-	-	-	-	-	-	-		
-	-	-	-	-	-	-	-	-	-	-	-	-	-	-	-	-	-	-	-	-	-	-		
-	-	-	-	-	-	-	-	-	-	-	-	-	-	-	-	-	-	-	-	-	-	-		
100	100	100	100	15	12	10	8	4	3	100	100	100	100	50	38	50	38	6	5	-	-	-		
100	100	50	38	10	8	6	5	4	3	100	100	100	100	50	38	42	32	6	5	-	-	-		
100	100	25	19	10	8	6	5	4	3	100	100	50	50	50	38	12	9	5	5	100	100	50	38	
50	38	25	19	10	8	6	5	4	3	100	100	50	50	50	38	12	9	5	5	100	100	50	38	
50	38	25	19	10	8	6	5	4	3	100	100	50	50	35	27	12	9	5	5	100	100	50	38	
50	38	25	19	10	8	6	5	4	3	100	100	50	50	35	27	10	8	5	5	100	100	50	38	
50	38	25	19	10	8	6	5	4	3	100	100	50	50	35	27	10	8	5	5	100	100	50	38	
50	38	25	19	10	8	6	5	4	3	100	100	50	50	35	27	10	8	5	5	100	100	50	38	
-	-	-	-	-	-	-	-	-	-	-	-	-	-	-	-	-	-	-	-	100	100	50	38	
-	-	-	-	-	-	-	-	-	-	-	-	-	-	-	-	-	-	-	-	100	100	50	38	
-	-	-	-	-	-	-	-	-	-	-	-	-	-	-	-	-	-	-	-	100	100	75	50	
-	-	-	-	-	-	-	-	-	-	-	-	-	-	-	-	-	-	-	-	100	100	75	50	

# Product Selection Guide

## Motor protection

- Adjustable thermal release
- Magnetic release  $13 \times I_e$  max.
- Trip class 10
- Ambient temperature compensation
- Phase-failure protection



GMS-32S



GMS-32H



(Circuit diagram)

Type	Rated operational current $I_e$ [A]	Thermal release Adjustment range [A]	Magnetic release Operating current [A]	Switching of 3 phase AC motors, AC-2, AC-3						440/460V		
				3-phase [kW] (50/60Hz)			3-phase [HP] (60Hz)			$I_{cu}$ [kA]	$I_{cs}$ [kA]	
				230V	400V	690V	230V	460V	575V			
GMS-32S (Standard)	0.16	0.1...0.16	2.1	-	0.02	-	-	-	-	-	100	100
	0.25	0.16...0.25	3.3	0.03	0.06	-	-	-	-	-	100	100
	0.4	0.25...0.4	5.2	0.06	0.09	-	-	-	-	-	100	100
	0.63	0.4...0.63	8.2	0.09	0.12	0.25	-	-	-	-	100	100
	1	0.63...1.0	13	0.12	0.25	0.55	-	1/2	1/2	-	100	100
	1.6	1.0...1.6	20.8	0.25	0.55	1.1	1/3	3/4	1	-	100	100
	2.5	1.6...2.5	32.5	0.37	0.75	1.5	1/2	1 1/2	1 1/2	-	100	100
	4	2.5...4.0	52	0.75	1.5	3	1	2	3	-	50	38
	6	4...6	78	1.5	2.2	4	1 1/2	5	5	-	15	11
	8	5...8	104	1.5	3	5.5	2	5	5	-	15	11
	10	6...10	130	3	4	7.5	3	7 1/2	10	-	15	11
	13	9...13	169	3	5.5	11	3	7 1/2	10	-	10	8
	17	11...17	221	4	7.5	11	5	10	15	-	10	8
	22	14...22	286	4	7.5	15	7 1/2	15	20	-	8	6
26	18...26	338	5.5	11	18.5	7 1/2	15	20	-	8	6	
32	22...32	416	7.5	15	22	10	20	30	-	6	4	
GMS-32H (High break)	0.16	0.1...0.16	2.1	-	0.02	-	-	-	-	-	100	100
	0.25	0.16...0.25	3.3	0.03	0.06	-	-	-	-	-	100	100
	0.4	0.25...0.4	5.2	0.06	0.09	-	-	-	-	-	100	100
	0.63	0.4...0.63	8.2	0.09	0.12	0.25	-	-	-	-	100	100
	1	0.63...1.0	13	0.12	0.25	0.55	-	1/2	1/2	-	100	100
	1.6	1.0...1.6	20.8	0.25	0.55	1.1	1/3	3/4	1	-	100	100
	2.5	1.6...2.5	32.5	0.37	0.75	1.5	1/2	1 1/2	1 1/2	-	100	100
	4	2.5...4.0	52	0.75	1.5	3	1	2	3	-	100	100
	6	4...6	78	1.5	2.2	4	1 1/2	5	5	-	100	100
	8	5...8	104	1.5	3	5.5	2	5	5	-	50	38
	10	6...10	130	3	4	7.5	3	7 1/2	10	-	50	38
	13	9...13	169	3	5.5	11	3	7 1/2	10	-	50	38
	17	11...17	221	4	7.5	11	5	10	15	-	20	15
	22	14...22	286	4	7.5	15	7 1/2	15	20	-	20	15
26	18...26	338	5.5	11	18.5	7 1/2	15	20	-	20	15	
32	22...32	416	7.5	15	22	10	20	30	-	20	15	

- Adjustable thermal release
- Magnetic release  $13 \times I_e$  max.
- Trip class 10
- Ambient temperature compensation
- Phase-failure protection

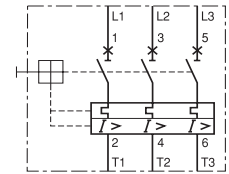

(Circuit diagram)

Type	Rated operational current $I_e$ [A]	Thermal release Adjustment range [A]	Magnetic release Operating current [A]	Switching of 3 phase AC motors, AC-2, AC-3						440/460V	
				3-phase [kW] (50/60Hz)			3-phase [HP] (60Hz)			$I_{cu}$ [kA]	$I_{cs}$ [kA]
				230V	400V	690V	230V	460V	575V		
GMS-63S (Standard)	10	6~10	130	3	4	7.5	3	7½	10	15	12
	13	9~13	169	3	5.5	11	3	7½	10	10	8
	17	11~17	221	4	7.5	11	5	10	15	10	8
	22	14~22	286	4	7.5	15	7½	15	20	10	8
	26	18~26	338	5.5	11	18.5	10	20	25	10	8
	32	22~32	416	7.5	15	22	10	25	30	10	8
	40	28~40	520	7.5	18.5	30	15	30	40	10	8
	50	34~50	650	11	22	45	15	40	50	10	8
GMS-63H (High break)	10	6~10	130	3	4	7.5	3	7½	10	50	38
	13	9~13	169	3	5.5	11	3	7½	10	50	38
	17	11~17	221	4	7.5	11	5	10	15	50	38
	22	14~22	286	4	7.5	15	7½	15	20	50	38
	26	18~26	338	5.5	11	18.5	10	20	25	35	27
	32	22~32	416	7.5	15	22	10	25	30	35	27
	40	28~40	520	7.5	18.5	30	15	30	40	35	27
	50	34~50	650	11	22	45	15	40	50	35	27
GMS-100S (Standard)	17	11~17	221	4	7.5	11	5	10	15	40	30
	22	14~22	286	4	7.5	15	7½	15	20	40	30
	26	18~26	338	5.5	11	18.5	10	20	25	40	30
	32	22~32	416	7.5	15	22	10	25	30	40	30
	40	28~40	520	7.5	18.5	30	15	30	40	40	30
	50	34~50	650	11	22	45	15	40	50	40	30
	63	45~63	819	15	30	55	20	50	60	40	30
	75	55~75	975	22	37	63	25	60	75	40	30
GMS-100H (High break)	17	11~17	221	4	7.5	11	5	10	15	50	38
	22	14~22	286	4	7.5	15	7½	15	20	50	38
	26	18~26	338	5.5	11	18.5	10	20	25	50	38
	32	22~32	416	7.5	15	22	10	25	30	50	38
	40	28~40	520	7.5	18.5	30	15	30	40	50	38
	50	34~50	650	11	22	45	15	40	50	50	38
	63	45~63	819	15	30	55	20	50	60	50	38
	75	55~75	975	22	37	63	25	60	75	50	38
90	70~90	1170	30	45	75	30	75	100	50	38	
100	80~100	1300	30	45	90	40	75	100	50	38	

# Product Selection Guide

## Short-circuit protection for starters

- Without thermal releases
- Magnetic release  $13 \times I_e$  max.



GMS-32HI



GMS-63HI



GMS-100HI

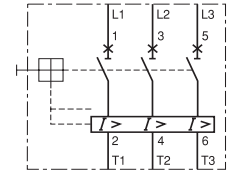

(Circuit diagram)

Type	Rated operational current $I_e$ [A]	Thermal release Adjustment range [A]	Magnetic release Operating current [A]	Switching of 3 phase AC motors, AC-2, AC-3						440/460V		
				3-phase [kW] (50/60Hz)			3-phase [HP] (60Hz)			$I_{cu}$ [kA]	$I_{cs}$ [kA]	
				230V	400V	690V	230V	460V	575V			
GMS-32HI (High break)	0.16	-	2.1	-	0.02	-	-	-	-	-	100	100
	0.25	-	3.3	0.03	0.06	-	-	-	-	-	100	100
	0.4	-	5.2	0.06	0.09	-	-	-	-	-	100	100
	0.63	-	8.2	0.09	0.12	0.25	-	-	-	-	100	100
	1	-	13	0.12	0.25	0.55	-	1/2	1/2	-	100	100
	1.6	-	20.8	0.25	0.55	1.1	1/3	3/4	1	-	100	100
	2.5	-	32.5	0.37	0.75	1.5	1/2	1 1/2	1 1/2	-	100	100
	4	-	52	0.75	1.5	3	1	2	3	-	100	100
	6	-	78	1.5	2.2	4	1 1/2	5	5	-	100	100
	8	-	104	1.5	3	5.5	2	5	5	-	50	38
	10	-	130	3	4	7.5	3	7 1/2	10	-	50	38
	13	-	169	3	5.5	11	3	7 1/2	10	-	50	38
	17	-	221	4	7.5	11	5	10	15	-	20	15
22	-	286	4	7.5	15	7 1/2	15	20	-	20	15	
26	-	338	5.5	11	18.5	7 1/2	15	20	-	20	15	
32	-	416	7.5	15	22	10	20	30	-	20	15	
GMS-63HI (High break)	10	-	130	3	4	7.5	3	7 1/2	10	-	50	38
	13	-	169	3	5.5	11	3	7 1/2	10	-	50	38
	17	-	221	4	7.5	11	5	10	15	-	50	38
	22	-	286	4	7.5	15	7 1/2	15	20	-	50	38
	26	-	338	5.5	11	18.5	10	20	25	-	35	27
	32	-	416	7.5	15	22	10	25	30	-	35	27
	40	-	520	7.5	18.5	30	15	30	40	-	35	27
50	-	650	11	22	45	15	40	50	-	35	27	
63	-	819	15	30	55	20	50	60	-	35	27	
GMS-100HI (High break)	17	-	221	4	7.5	11	5	10	15	-	50	38
	22	-	286	4	7.5	15	7 1/2	15	20	-	50	38
	26	-	338	5.5	11	18.5	10	20	25	-	50	38
	32	-	416	7.5	15	22	10	25	30	-	50	38
	40	-	520	7.5	18.5	30	15	30	40	-	50	38
	50	-	650	11	22	45	15	40	50	-	50	38
	63	-	819	15	30	55	20	50	60	-	50	38
	75	-	975	22	37	63	25	60	75	-	50	38
90	-	1170	30	45	75	30	75	100	-	50	38	
100	-	1300	30	45	90	40	75	100	-	50	38	



# Motor protection ... Class 20

- Adjustable thermal release
- Magnetic release  $13 \times I_e$  max.
- Trip class 20
- Ambient temperature compensation
- Phase-failure protection



GMS-63H



GMS-100H

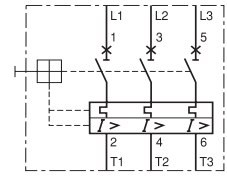





(Circuit diagram)

Type	Rated operational current $I_e$ [A]	Thermal release Adjustment range [A]	Magnetic release Operating current [A]	Switching of 3 phase AC motors, AC-2, AC-3						440/460V	
				3-phase [kW] (50/60Hz)			3-phase [HP] (60Hz)			$I_{cu}$ [kA]	$I_{cs}$ [kA]
				230V	400V	690V	230V	460V	575V		
GMS-63HL (High break)	10	6~10	130	3	4	7.5	3	7½	10	50	38
	13	9~13	169	3	5.5	11	3	7½	10	50	38
	17	11~17	221	4	7.5	11	5	10	15	50	38
	22	14~22	286	4	7.5	15	7½	15	20	50	38
	26	18~26	338	5.5	11	18.5	10	20	25	35	27
	32	22~32	416	7.5	15	22	10	25	30	35	27
	40	28~40	520	7.5	18.5	30	15	30	40	35	27
	50	34~50	650	11	22	45	15	40	50	35	27
GMS-100HL (High break)	63	45~63	819	15	30	55	20	50	60	35	27
	17	11~17	221	4	7.5	11	5	10	15	50	38
	22	14~22	286	4	7.5	15	7½	15	20	50	38
	26	18~26	338	5.5	11	18.5	10	20	25	50	38
	32	22~32	416	7.5	15	22	10	25	30	50	38
	40	28~40	520	7.5	18.5	30	15	30	40	50	38
	50	34~50	650	11	22	45	15	40	50	50	38
	63	45~63	819	15	30	55	20	50	60	50	38
75	55~75	975	22	37	63	25	60	75	50	38	
90	70~90	1170	30	45	75	30	75	100	50	38	
100	80~100	1300	30	45	90	40	75	100	50	38	

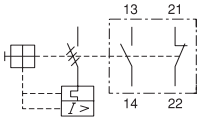
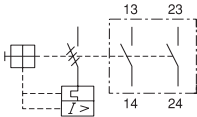
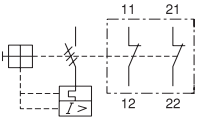
# Product Selection Guide

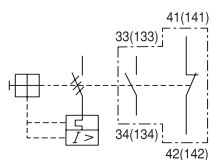
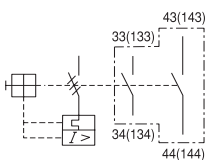
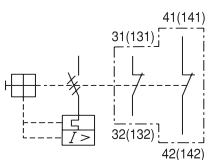
## Accessories





Type	Description	Connection diagram		
<b>GFX...</b> 	Auxiliary Switch <ul style="list-style-type: none"> <li>· Front mounting</li> <li>· 2-pole</li> <li>· One front mounting module per circuit breaker</li> </ul>	1NO1NC  <b>GFX-11</b>	2NO  <b>GFX-20</b>	2NC  <b>GFX-02</b>
<b>GSX...</b> 	Auxiliary Switch <ul style="list-style-type: none"> <li>· Side mounting on the left</li> <li>· 2-pole</li> <li>· One side mounting module per circuit breaker</li> </ul>	1NO1NC  <b>GSX-11</b>	2NO  <b>GSX-20</b>	2NC  <b>GSX-02</b>
<b>GSA...</b> 	Any Trip Alarm Switch <ul style="list-style-type: none"> <li>· Side mounting on the left</li> <li>· 2-pole</li> <li>· One side mounting module per circuit breaker. (Always directly fitted to the circuit breaker).</li> </ul>	<b>GMS-32: GMS-63/100:</b> <b>GSA32-11 GSA63100-11</b>	<b>GSA32-20 GSA63100-20</b>	<b>GSA32-02 GSA63100-02</b>
<b>GMA...</b> 	Magnetic Trip Alarm Switch <ul style="list-style-type: none"> <li>· Side mounting on the left</li> <li>· 2-pole</li> <li>· One side mounting module per circuit breaker. (Always directly fitted to the circuit breaker except using with Any Trip Alarm Switch).</li> </ul>	<b>GMA-11</b>	<b>GMA-20</b>	<b>GMA-02</b>

### Ordering Example: Specify Contact Arrangement

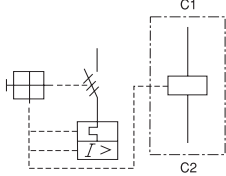

GFX-11 (1NO 1NC)

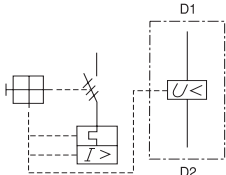
GFX-20 (2NO)

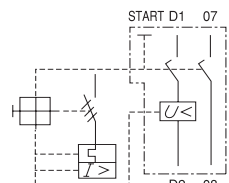
GFX-02 (2NC)

Type	Description	Connection diagram	
<b>GSR...</b> 	<b>Shunt release</b> <ul style="list-style-type: none"> <li>Side mounting on the right</li> <li>One side mounting module per circuit breaker. (Always directly fitted to the circuit breaker).</li> </ul>		24V 50Hz / 28V 60Hz 110~127V 50Hz / 120V 60Hz 220~230V 50Hz / 240~260V 60Hz 240V 50Hz / 277V 60Hz 380~400V 50Hz / 440~460V 60Hz 415~440V 50Hz / 460~480V 60Hz
<b>GUR...</b> 	<b>Undervoltage release</b> <ul style="list-style-type: none"> <li>Side mounting on the right</li> <li>One side mounting module per circuit breaker. (Always directly fitted to the circuit breaker).</li> </ul>		24V 50Hz / 28V 60Hz 110~127V 50Hz / 120V 60Hz 220~230V 50Hz / 240~260V 60Hz 240V 50Hz / 277V 60Hz 380~400V 50Hz / 440~460V 60Hz 415~440V 50Hz / 460~480V 60Hz
<b>GURX...</b> 	<b>Undervoltage release with Switch</b> (Rotary Handle Only) <ul style="list-style-type: none"> <li>Side mounting on the right</li> <li>Include 2NO Auxiliary contact</li> <li>One side mounting module per circuit breaker. (Always directly fitted to the circuit breaker).</li> </ul>		24V 50Hz / 28V 60Hz 110~127V 50Hz / 120V 60Hz 220~230V 50Hz / 240~260V 60Hz 240V 50Hz / 277V 60Hz 380~400V 50Hz / 440~460V 60Hz 415~440V 50Hz / 460~480V 60Hz

## Others

Type	Description	Applied Type
<b>PIL32</b> 	<b>Push-in lug</b> <ul style="list-style-type: none"> <li>For screwing the MMS on to mounting plates.</li> </ul>	<b>GMS-32S</b> <b>GMS-32H</b>
<b>IB100</b> 	<b>Insulation barriers</b> <ul style="list-style-type: none"> <li>Insulation barriers with increased creepage distances and clearances for UL.</li> </ul>	<b>GMS-100S</b> <b>GMS-100H</b>



## ● E-Handle (Rotary-type)

GMS E-Handle is a Rotary-type Handle accessory which can be attached to the front to control and verify the ON, TRIP, OFF condition of Manual Motor Starters under the situation of closing panel.

- Application Model : GMS-32H/HI, GMS-63S/H/HI, GMS-100S/H/HI
- Operation temp. : -20~ +60°C
- CE and UL certified
- Degree of protection : IP65
- Locking device : Lockable in on/off position
- Material of insulation : Plastic(PA66)

Type	Application MMS	Remarks
GEH32	GMS-32H, 32HI	Length of shaft : 115 or 315mm
GEH63	GMS-63S, 63H, 63HI	
GEH100	GMS-100S, 100H, 100HI	



## ● Enclosure

Case cover of GMS enclosure is specifically designed with dust-proof and corrosive-proof structure.

Therefore, it is the optimum product to use in dusty areas such as cement plants, cotton mills as well as in the presence of corrosive gas or liquid (excl. explosive, flammable gas) such as fertilizer, refinery, and plating plant.

- Application Model: GMS-32H/HI
- Operation temp. : -20~ +60°C
- CE and UL certified
- Degree of protection : IP65
- Material of insulation : Plastic(ABS)

Type	Application MMS	Remarks
GEP32A65S	GMS-32H, 32HI	Surface mount

## ● Direct adaptor and Mounting unit

### Direct adaptor , GDA

Direct adaptor is used to connect GMS directly with a contactor

### Mounting unit , GMU

This device allows for mounting joined contactor and GMS onto a common back plate.

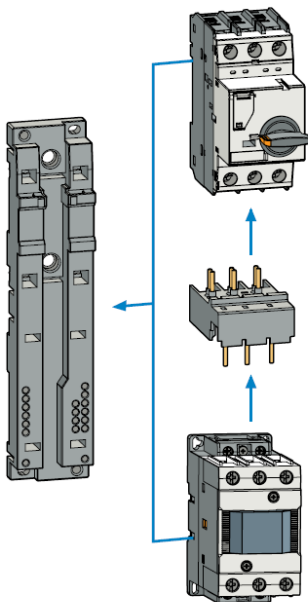

Contactor	Mounting Unit	Manual Motor Starter	Adapter
CGMS-6A, CGMS-9A, CGMS-12A	GMU45	GMS-32H	GDA16HA
		GMS-32S	GDA16SA
CGMS-6D, CGMS-9D, CGMS-12D		GMS-32H	GDA16HD
		GMS-32S	GDA16SD
CC9SA, CC12SA, CC18SA, CC22SA		GMS-32H	GDA22HA
		GMS-32S	GDA22SA
CC9SD, CC12SD, CC18SD, CC22SD		GMS-32H	GDA22HD
		GMS-32S	GDA22SD
CC32SA, CC40SA		GMS-32H	GDA32HA
		GMS-32S	GDA32SA
CC32SD, CC40SD		GMS-32H	GDA32HD
		GMS-32S	GDA32SD
CC50LA, CC65LA CC50LD, CC65LS	GMU55	GMS-63H, GMS-63S	GDA63A
		GMS-63H, GMS-63S	GDA63D
CC75LA, CC85LA, CC100LA CC75LD, CC85LD, CC100LD	GMU70	GMS-100H, GMS-100S	GDA95A
		GMS-100H, GMS-100S	GDA95D



# Product Selection Guide

## Busbar accessories



	45mm Spacing (rated 63A)	54mm Spacing (rated 63A)	63mm Spacing (rated 63A)	Jumper
<b>Type</b>	<b>MSVGW45-14-2</b>	<b>MSVGW54-14-2</b>	<b>MSVGW63-14-2</b>	<b>MSVGW45-SH</b>
<b>Description</b>	For 2 GMS-32S/H	For 2 GMS-32S/H + accessories (side mnt aux. sw)	For 2 GMS-32S/H + accessories (side mnt undervoltage or shunt trip)	For connecting GMS-32S W/ GMS-32H
<b>Type</b>	<b>MSVGW45-14-3</b>	<b>MSVGW54-14-3</b>	<b>MSVGW63-14-3</b>	
<b>Description</b>	For 3 GMS-32S/H	For 3 GMS-32S/H + accessories (side mnt aux. sw)	For 3 GMS-32S/H + accessories (side mnt undervoltage or shunt trip)	
<b>Type</b>	<b>MSVGW45-14-4</b>	<b>MSVGW54-14-4</b>	<b>MSVGW63-14-4</b>	
<b>Description</b>	For 4 GMS-32S/H	For 4 GMS-32S/H + accessories (side mnt aux. sw)	For 4 GMS-32S/H + accessories (side mnt undervoltage or shunt trip)	
<b>Type</b>	<b>MSVGW45-14-5</b>	<b>MSVGW54-14-5</b>	<b>MSVGW63-14-5</b>	
<b>Description</b>	For 5 GMS-32S/H	For 5 GMS-32S/H + accessories (side mnt aux. sw)	For 5 GMS-32S/H + accessories (side mnt undervoltage or shunt trip)	



54mm Spacing (rated 120A)	63mm Spacing (rated 120A)	Terminal cover	Supply connector	Connection module
<b>MSVCPM25412</b> For 2 GMS-63	<b>MSVCP36312</b> For 2 GMS-63 + accessories (side mnt aux sw)	<b>MSVB54</b> 3 Pole protective cover for MSVGW..	<b>MSVGWE1-14</b> 3 Phase input terminal 63A	<b>GDA16SA</b> For connecting GMS-32S to CGMS-6A - CGMS-12A
<b>MSVCPM35412</b> For 3 GMS-63	<b>MSVCP36312</b> For 3 GMS-63 + accessories (side mnt aux. sw)	<b>MSVTA120</b> 3 Pole protective cover for MSVCP..	<b>MSVBTC50E</b> 3 Phase Input terminal 120A	<b>GDA16SD</b> For connecting GMS-32S to CGMS-6D - CGMS-12D
<b>MSVCPM45412</b> For 4 GMS-63	<b>MSVCP46312</b> For 4 GMS-63 + accessories (side mnt aux. sw)			<b>GDA16HA</b> For connecting GMS-32H to CGMS-6A - CGMS-12A
				<b>GDA16HD</b> For connecting GMS-32H to CGMS-6D - CGMS-12D

## IEC performance data (Motor protection)



### ● GMS-100S

Rated operational current $I_e$ [A]		17	22	26	32	40	50	63	75	90	100
<b>Switching of standard three-phase motors</b>											
AC-2, AC-3											
230/240V [kW]		3.7/4	4	5.5	7.5	7.5	11	15	22	30	30
400/415V [kW]		7.5	7.5	11	15	18.5	22	30	37	45	45
500V [kW]		11	11	15	18.5	22	30	37	45	55	63
690V [kW]		11	15	18.5	22	30	45	55	63	75	90
<b>Back-up fuses</b>											
gG, gL., only if $I_{cc} > I_{cu}$ (* = No back up fuse required)											
230/240V [A]		*	*	*	*	*	*	*	*	*	*
400/415V [A]		100	125	125	125	160	160	160	160	160	160
440/460V [A]		100	125	125	125	125	125	160	160	160	160
500V [A]		100	100	100	100	100	100	100	125	125	125
690V [A]		63	80	80	80	80	80	80	100	125	125
<b>Ultimate short-circuit breaking capacity <math>I_{cu}</math></b>											
230/240V [kA]		100	100	100	100	100	100	100	100	100	100
400/415V [kA]		50	50	50	50	50	50	50	50	50	50
440/460V [kA]		40	40	40	40	40	40	40	40	40	40
500V [kA]		25	25	25	15	15	12	12	8	8	8
690V [kA]		10	10	10	10	6	6	6	5	5	5
<b>Rated service short-circuit breaking capacity <math>I_{cs}</math></b>											
230/240V [kA]		100	100	100	100	100	100	100	100	100	100
400/415V [kA]		38	38	38	38	38	38	38	38	38	38
440/460V [kA]		30	30	30	30	30	30	30	30	30	30
500V [kA]		19	19	19	11	11	9	9	6	6	6
690V [kA]		8	8	8	8	5	5	5	4	4	4



### ● GMS-100H

Rated operational current $I_e$ [A]		17	22	26	32	40	50	63	75	90	100
<b>Switching of standard three-phase motors</b>											
AC-2, AC-3											
230/240V [kW]		3.7/4	4	5.5	7.5	7.5	11	15	22	30	30
400/415V [kW]		7.5	7.5	11	15	18.5	22	30	37	45	45
500V [kW]		11	11	15	18.5	22	30	37	45	55	63
690V [kW]		11	15	18.5	22	30	45	55	63	75	90
<b>Back-up fuses</b>											
gG, gL., only if $I_{cc} > I_{cu}$ (* = No back up fuse required)											
230/240V [A]		*	*	*	*	*	*	*	*	*	*
400/415V [A]		*	*	*	*	*	*	*	*	*	*
440/460V [A]		125	125	125	160	160	160	200	200	200	200
500V [A]		100	125	125	125	160	160	160	160	160	160
690V [A]		80	80	80	80	80	100	100	125	160	160
<b>Ultimate short-circuit breaking capacity <math>I_{cu}</math></b>											
230/240V [kA]		100	100	100	100	100	100	100	100	100	100
400/415V [kA]		100	100	100	100	100	100	100	75	75	75
440/460V [kA]		50	50	50	50	50	50	50	50	50	50
500V [kA]		35	35	35	25	20	15	15	12	12	12
690V [kA]		12	12	12	12	12	10	8	6	6	6
<b>Rated service short-circuit breaking capacity <math>I_{cs}</math></b>											
230/240V [kA]		100	100	100	100	100	100	100	100	100	100
400/415V [kA]		100	50	50	50	50	50	50	50	50	50
440/460V [kA]		38	38	38	38	38	38	38	38	38	38
500V [kA]		27	27	27	19	15	11	11	9	9	9
690V [kA]		9	9	9	9	9	8	6	6	6	6

Note) \* = Short circuit proof up to 50 or 100kA.  
No back up fuse required.

# IEC performance data (Short-circuit protection for starters)

## ● GMS-32HI

Rated operational current I <sub>e</sub>	[A]	0.16	0.25	0.4	0.63	1	1.6	2.5	4	6	8	10	13	17	22	26	32
<b>AC-2, AC-3</b>																	
230/240V	[kW]	-	0.03	0.06	0.09	0.12	0.18/0.25	0.37	0.55/0.75	1.1/1.5	1.5	2.2/3	3	3.7/4	4	5.5	7.5
400/415V	[kW]	0.02	0.06	0.09	0.12	0.18/0.25	0.37/0.55	0.75	1.1/1.5	2.2	3	3.7/4	5.5	7.5	7.5	11	15
500V	[kW]	-	-	-	0.25	0.37	0.55/0.75	1.1	1.5/2.2	3	3.7	4/5.5	7.5	11	11	15	18.5
690V	[kW]	-	-	-	0.25	0.37/0.55	0.75/1.1	1.5	2.2/3	3.7/4	5.5	7.5	11	11	15	18.5	22
<b>Back-up fuses</b> gG, gL, only if I <sub>cc</sub> >I <sub>cu</sub> (* = No back up fuse required)																	
230/240V	[A]	*	*	*	*	*	*	*	*	*	*	*	*	*	*	*	*
400/415V	[A]	*	*	*	*	*	*	*	*	*	*	*	*	100	125	125	125
440/460V	[A]	*	*	*	*	*	*	*	*	*	80	80	80	80	100	100	100
500V	[A]	*	*	*	*	*	*	*	*	*	63	80	80	80	80	80	80
690V	[A]	*	*	*	*	*	*	35	40	50	63	63	63	63	63	63	63
<b>Ultimate short-circuit breaking capacity I<sub>cu</sub></b>																	
230/240V	[kA]	100	100	100	100	100	100	100	100	100	100	100	100	100	100	100	100
400/415V	[kA]	100	100	100	100	100	100	100	100	100	100	100	100	50	50	50	50
440/460V	[kA]	100	100	100	100	100	100	100	100	100	50	50	50	20	20	20	20
500V	[kA]	100	100	100	100	100	100	100	100	100	50	50	42	10	10	10	10
690V	[kA]	100	100	100	100	100	100	8	8	6	6	6	6	4	4	4	4
<b>Rated service short-circuit breaking capacity I<sub>cs</sub></b>																	
230/240V	[kA]	100	100	100	100	100	100	100	100	100	100	100	100	100	100	100	100
400/415V	[kA]	100	100	100	100	100	100	100	100	100	100	100	100	38	38	38	38
440/460V	[kA]	100	100	100	100	100	100	100	100	100	38	38	38	15	15	15	15
500V	[kA]	100	100	100	100	100	100	100	100	100	38	38	32	8	8	8	8
690V	[kA]	100	100	100	100	100	100	8	8	6	6	6	6	4	4	4	4

## ● GMS-63HI

Rated operational current I <sub>e</sub>	[A]	10	13	17	22	26	32	40	50	63
<b>AC-2, AC-3</b>										
230/240V	[kW]	2.2/3	3	3.7/4	4	5.5	7.5	7.5	11	15
400/415V	[kW]	3.7/4	5.5	7.5	7.5	11	15	18.5	22	30
500V	[kW]	4/5.5	7.5	11	11	15	18.5	22	30	37
690V	[kW]	7.5	11	11	15	18.5	22	30	45	55
<b>Back-up fuses</b> gG, gL, only if I <sub>cc</sub> >I <sub>cu</sub> (* = No back up fuse required)										
230/240V	[A]	*	*	*	*	*	*	*	*	*
400/415V	[A]	*	*	100	125	125	125	160	160	160
440/460V	[A]	100	100	100	125	125	125	125	125	160
500V	[A]	100	100	100	100	100	100	100	100	100
690V	[A]	63	63	63	80	80	80	80	80	80
<b>Ultimate short-circuit breaking capacity I<sub>cu</sub></b>										
230/240V	[kA]	100	100	100	100	100	100	100	100	100
400/415V	[kA]	100	100	50	50	50	50	50	50	50
440/460V	[kA]	50	50	50	50	35	35	35	35	35
500V	[kA]	50	42	12	12	12	10	10	10	10
690V	[kA]	6	6	5	5	5	5	5	5	5
<b>Rated service short-circuit breaking capacity I<sub>cs</sub></b>										
230/240V	[kA]	100	100	100	100	100	100	100	100	100
400/415V	[kA]	100	100	50	50	50	50	50	50	50
440/460V	[kA]	38	38	38	38	27	27	27	27	27
500V	[kA]	38	32	9	9	9	8	8	8	8
690V	[kA]	5	5	5	5	5	5	5	5	5

## ● GMS-100HI

Rated operational current I <sub>e</sub>	[A]	17	22	26	32	40	50	63	75	90	100
<b>AC-2, AC-3</b>											
230/240V	[kW]	3.7/4	4	5.5	7.5	7.5	11	15	22	30	30
400/415V	[kW]	7.5	7.5	11	15	18.5	22	30	37	45	45
500V	[kW]	11	11	15	18.5	22	30	37	45	55	63
690V	[kW]	11	15	18.5	22	30	45	55	63	75	90
<b>Back-up fuses</b> gG, gL, only if I <sub>cc</sub> >I <sub>cu</sub> (* = No back up fuse required)											
230/240V	[A]	*	*	*	*	*	*	*	*	*	*
400/415V	[A]	*	*	*	*	*	*	*	*	*	*
440/460V	[A]	125	125	125	160	160	160	200	200	200	200
500V	[A]	100	125	125	125	160	160	160	160	160	160
690V	[A]	80	80	80	80	80	100	100	125	160	160
<b>Ultimate short-circuit breaking capacity I<sub>cu</sub></b>											
230/240V	[kA]	100	100	100	100	100	100	100	100	100	100
400/415V	[kA]	100	100	100	100	100	100	100	75	75	75
440/460V	[kA]	50	50	50	50	50	50	50	50	50	50
500V	[kA]	35	35	35	25	20	15	15	12	12	12
690V	[kA]	12	12	12	12	12	10	8	6	6	6
<b>Rated service short-circuit breaking capacity I<sub>cs</sub></b>											
230/240V	[kA]	100	100	100	100	100	100	100	100	100	100
400/415V	[kA]	100	50	50	50	50	50	50	50	50	50
440/460V	[kA]	38	38	38	38	38	38	38	38	38	38
500V	[kA]	27	27	27	19	15	11	11	9	9	9
690V	[kA]	9	9	9	9	9	8	6	6	6	6

## IEC performance data (Motor protection)



### ● GMS-100S

Rated operational current $I_e$ [A]		17	22	26	32	40	50	63	75	90	100
<b>Switching of standard three-phase motors</b>											
AC-2, AC-3											
230/240V [kW]		3.7/4	4	5.5	7.5	7.5	11	15	22	30	30
400/415V [kW]		7.5	7.5	11	15	18.5	22	30	37	45	45
500V [kW]		11	11	15	18.5	22	30	37	45	55	63
690V [kW]		11	15	18.5	22	30	45	55	63	75	90
<b>Back-up fuses</b>											
gG, gL., only if $I_{cc} > I_{cu}$ (* = No back up fuse required)											
230/240V [A]		*	*	*	*	*	*	*	*	*	*
400/415V [A]		100	125	125	125	160	160	160	160	160	160
440/460V [A]		100	125	125	125	125	125	160	160	160	160
500V [A]		100	100	100	100	100	100	100	125	125	125
690V [A]		63	80	80	80	80	80	80	100	125	125
<b>Ultimate short-circuit breaking capacity <math>I_{cu}</math></b>											
230/240V [kA]		100	100	100	100	100	100	100	100	100	100
400/415V [kA]		50	50	50	50	50	50	50	50	50	50
440/460V [kA]		40	40	40	40	40	40	40	40	40	40
500V [kA]		25	25	25	15	15	12	12	8	8	8
690V [kA]		10	10	10	10	6	6	6	5	5	5
<b>Rated service short-circuit breaking capacity <math>I_{cs}</math></b>											
230/240V [kA]		100	100	100	100	100	100	100	100	100	100
400/415V [kA]		38	38	38	38	38	38	38	38	38	38
440/460V [kA]		30	30	30	30	30	30	30	30	30	30
500V [kA]		19	19	19	11	11	9	9	6	6	6
690V [kA]		8	8	8	8	5	5	5	4	4	4



### ● GMS-100H

Rated operational current $I_e$ [A]		17	22	26	32	40	50	63	75	90	100
<b>Switching of standard three-phase motors</b>											
AC-2, AC-3											
230/240V [kW]		3.7/4	4	5.5	7.5	7.5	11	15	22	30	30
400/415V [kW]		7.5	7.5	11	15	18.5	22	30	37	45	45
500V [kW]		11	11	15	18.5	22	30	37	45	55	63
690V [kW]		11	15	18.5	22	30	45	55	63	75	90
<b>Back-up fuses</b>											
gG, gL., only if $I_{cc} > I_{cu}$ (* = No back up fuse required)											
230/240V [A]		*	*	*	*	*	*	*	*	*	*
400/415V [A]		*	*	*	*	*	*	*	*	*	*
440/460V [A]		125	125	125	160	160	160	200	200	200	200
500V [A]		100	125	125	125	160	160	160	160	160	160
690V [A]		80	80	80	80	80	100	100	125	160	160
<b>Ultimate short-circuit breaking capacity <math>I_{cu}</math></b>											
230/240V [kA]		100	100	100	100	100	100	100	100	100	100
400/415V [kA]		100	100	100	100	100	100	100	75	75	75
440/460V [kA]		50	50	50	50	50	50	50	50	50	50
500V [kA]		35	35	35	25	20	15	15	12	12	12
690V [kA]		12	12	12	12	12	10	8	6	6	6
<b>Rated service short-circuit breaking capacity <math>I_{cs}</math></b>											
230/240V [kA]		100	100	100	100	100	100	100	100	100	100
400/415V [kA]		100	50	50	50	50	50	50	50	50	50
440/460V [kA]		38	38	38	38	38	38	38	38	38	38
500V [kA]		27	27	27	19	15	11	11	9	9	9
690V [kA]		9	9	9	9	9	8	6	6	6	6

Note) \* = Short circuit proof up to 50 or 100kA.  
No back up fuse required.

# IEC performance data (Short-circuit protection for starters)

## ● GMS-32HI

Rated operational current I <sub>e</sub>	[A]	0.16	0.25	0.4	0.63	1	1.6	2.5	4	6	8	10	13	17	22	26	32
<b>AC-2, AC-3</b>																	
230/240V	[kW]	-	0.03	0.06	0.09	0.12	0.18/0.25	0.37	0.55/0.75	1.1/1.5	1.5	2.2/3	3	3.7/4	4	5.5	7.5
400/415V	[kW]	0.02	0.06	0.09	0.12	0.18/0.25	0.37/0.55	0.75	1.1/1.5	2.2	3	3.7/4	5.5	7.5	7.5	11	15
500V	[kW]	-	-	-	0.25	0.37	0.55/0.75	1.1	1.5/2.2	3	3.7	4/5.5	7.5	11	11	15	18.5
690V	[kW]	-	-	-	0.25	0.37/0.55	0.75/1.1	1.5	2.2/3	3.7/4	5.5	7.5	11	11	15	18.5	22
<b>Back-up fuses</b> gG, gL., only if I <sub>cc</sub> >I <sub>cu</sub> (* = No back up fuse required)																	
230/240V	[A]	*	*	*	*	*	*	*	*	*	*	*	*	*	*	*	*
400/415V	[A]	*	*	*	*	*	*	*	*	*	*	*	*	100	125	125	125
440/460V	[A]	*	*	*	*	*	*	*	*	80	80	80	80	100	100	100	100
500V	[A]	*	*	*	*	*	*	*	*	63	80	80	80	80	80	80	80
690V	[A]	*	*	*	*	*	*	35	40	50	63	63	63	63	63	63	63
<b>Ultimate short-circuit breaking capacity I<sub>cu</sub></b>																	
230/240V	[kA]	100	100	100	100	100	100	100	100	100	100	100	100	100	100	100	100
400/415V	[kA]	100	100	100	100	100	100	100	100	100	100	100	100	50	50	50	50
440/460V	[kA]	100	100	100	100	100	100	100	100	100	50	50	50	20	20	20	20
500V	[kA]	100	100	100	100	100	100	100	100	100	50	50	42	10	10	10	10
690V	[kA]	100	100	100	100	100	100	8	8	6	6	6	6	4	4	4	4
<b>Rated service short-circuit breaking capacity I<sub>cs</sub></b>																	
230/240V	[kA]	100	100	100	100	100	100	100	100	100	100	100	100	100	100	100	100
400/415V	[kA]	100	100	100	100	100	100	100	100	100	100	100	100	38	38	38	38
440/460V	[kA]	100	100	100	100	100	100	100	100	100	38	38	38	15	15	15	15
500V	[kA]	100	100	100	100	100	100	100	100	100	38	38	32	8	8	8	8
690V	[kA]	100	100	100	100	100	100	8	8	6	6	6	6	4	4	4	4

## ● GMS-63HI

Rated operational current I <sub>e</sub>	[A]	10	13	17	22	26	32	40	50	63
<b>AC-2, AC-3</b>										
230/240V	[kW]	2.2/3	3	3.7/4	4	5.5	7.5	7.5	11	15
400/415V	[kW]	3.7/4	5.5	7.5	7.5	11	15	18.5	22	30
500V	[kW]	4/5.5	7.5	11	11	15	18.5	22	30	37
690V	[kW]	7.5	11	11	15	18.5	22	30	45	55
<b>Back-up fuses</b> gG, gL., only if I <sub>cc</sub> >I <sub>cu</sub> (* = No back up fuse required)										
230/240V	[A]	*	*	*	*	*	*	*	*	*
400/415V	[A]	*	*	100	125	125	125	160	160	160
440/460V	[A]	100	100	100	125	125	125	125	125	160
500V	[A]	100	100	100	100	100	100	100	100	100
690V	[A]	63	63	63	80	80	80	80	80	80
<b>Ultimate short-circuit breaking capacity I<sub>cu</sub></b>										
230/240V	[kA]	100	100	100	100	100	100	100	100	100
400/415V	[kA]	100	100	50	50	50	50	50	50	50
440/460V	[kA]	50	50	50	50	35	35	35	35	35
500V	[kA]	50	42	12	12	12	10	10	10	10
690V	[kA]	6	6	5	5	5	5	5	5	5
<b>Rated service short-circuit breaking capacity I<sub>cs</sub></b>										
230/240V	[kA]	100	100	100	100	100	100	100	100	100
400/415V	[kA]	100	100	50	50	50	50	50	50	50
440/460V	[kA]	38	38	38	38	27	27	27	27	27
500V	[kA]	38	32	9	9	9	8	8	8	8
690V	[kA]	5	5	5	5	5	5	5	5	5

## ● GMS-100HI

Rated operational current I <sub>e</sub>	[A]	17	22	26	32	40	50	63	75	90	100
<b>AC-2, AC-3</b>											
230/240V	[kW]	3.7/4	4	5.5	7.5	7.5	11	15	22	30	30
400/415V	[kW]	7.5	7.5	11	15	18.5	22	30	37	45	45
500V	[kW]	11	11	15	18.5	22	30	37	45	55	63
690V	[kW]	11	15	18.5	22	30	45	55	63	75	90
<b>Back-up fuses</b> gG, gL., only if I <sub>cc</sub> >I <sub>cu</sub> (* = No back up fuse required)											
230/240V	[A]	*	*	*	*	*	*	*	*	*	*
400/415V	[A]	*	*	*	*	*	*	*	*	*	*
440/460V	[A]	125	125	125	160	160	160	200	200	200	200
500V	[A]	100	125	125	125	160	160	160	160	160	160
690V	[A]	80	80	80	80	80	100	100	125	160	160
<b>Ultimate short-circuit breaking capacity I<sub>cu</sub></b>											
230/240V	[kA]	100	100	100	100	100	100	100	100	100	100
400/415V	[kA]	100	100	100	100	100	100	100	75	75	75
440/460V	[kA]	50	50	50	50	50	50	50	50	50	50
500V	[kA]	35	35	35	25	20	15	15	12	12	12
690V	[kA]	12	12	12	12	12	10	8	6	6	6
<b>Rated service short-circuit breaking capacity I<sub>cs</sub></b>											
230/240V	[kA]	100	100	100	100	100	100	100	100	100	100
400/415V	[kA]	100	50	50	50	50	50	50	50	50	50
440/460V	[kA]	38	38	38	38	38	38	38	38	38	38
500V	[kA]	27	27	27	19	15	11	11	9	9	9
690V	[kA]	9	9	9	9	9	8	6	6	6	6

## IEC performance data (Motor protection ; Class 20)



### ● GMS-63HL

Rated operational current $I_e$ [A]		10	13	17	22	26	32	40	50	63
<b>Switching of standard three-phase motors</b>										
AC-2, AC-3										
230/240V [kW]		2.2/3	3	3.7/4	4	5.5	7.5	7.5	11	15
400/415V [kW]		3.7/4	5.5	7.5	7.5	11	15	18.5	22	30
500V [kW]		4/5.5	7.5	11	11	15	18.5	22	30	37
690V [kW]		7.5	11	11	15	18.5	22	30	45	55
<b>Back-up fuses</b>										
gG, gL <sub>+</sub> , only if $I_{cc} > I_{cu}$ (* = No back up fuse required)										
230/240V [A]		*	*	*	*	*	*	*	*	*
400/415V [A]		*	*	100	125	125	125	160	160	160
440/460V [A]		100	100	100	125	125	125	125	125	160
500V [A]		100	100	100	100	100	100	100	100	100
690V [A]		63	63	63	80	80	80	80	80	80
<b>Ultimate short-circuit breaking capacity <math>I_{cu}</math></b>										
230/240V [kA]		100	100	100	100	100	100	100	100	100
400/415V [kA]		100	100	50	50	50	50	50	50	50
440/460V [kA]		50	50	50	50	35	35	35	35	35
500V [kA]		50	42	12	12	10	10	10	10	10
690V [kA]		6	6	5	5	5	5	5	5	5
<b>Rated service short-circuit breaking capacity <math>I_{cs}</math></b>										
230/240V [kA]		100	100	100	100	100	100	100	100	100
400/415V [kA]		100	100	50	50	50	50	50	50	50
440/460V [kA]		38	38	38	38	27	27	27	27	27
500V [kA]		38	32	9	9	8	8	8	8	8
690V [kA]		5	5	5	5	5	5	5	5	5



### ● GMS-100HL

Rated operational current $I_e$ [A]		17	22	26	32	40	50	63	75	90	100
<b>Switching of standard three-phase motors</b>											
AC-2, AC-3											
230/240V [kW]		3.7/4	4	5.5	7.5	7.5	11	15	22	30	30
400/415V [kW]		7.5	7.5	11	15	18.5	22	30	37	45	45
500V [kW]		11	11	15	18.5	22	30	37	45	55	63
690V [kW]		11	15	18.5	22	30	45	55	63	75	90
<b>Back-up fuses</b>											
gG, gL <sub>+</sub> , only if $I_{cc} > I_{cu}$ (* = No back up fuse required)											
230/240V [A]		*	*	*	*	*	*	*	*	*	*
400/415V [A]		*	*	*	*	*	*	*	*	*	*
440/460V [A]		125	125	125	160	160	160	200	200	200	200
500V [A]		100	125	125	125	160	160	160	160	160	160
690V [A]		80	80	80	80	80	100	100	125	160	160
<b>Ultimate short-circuit breaking capacity <math>I_{cu}</math></b>											
230/240V [kA]		100	100	100	100	100	100	100	100	100	100
400/415V [kA]		100	100	100	100	100	100	100	75	75	75
440/460V [kA]		50	50	50	50	50	50	50	50	50	50
500V [kA]		35	35	35	25	20	15	15	12	12	12
690V [kA]		12	12	12	12	12	10	8	6	6	6
<b>Rated service short-circuit breaking capacity <math>I_{cs}</math></b>											
230/240V [kA]		100	100	100	100	100	100	100	100	100	100
400/415V [kA]		100	50	50	50	50	50	50	50	50	50
440/460V [kA]		38	38	38	38	38	38	38	38	38	38
500V [kA]		27	27	27	19	15	11	11	9	9	9
690V [kA]		9	9	9	9	9	8	6	6	6	6

Note) \* = Short circuit proof up to 50 or 100kA.  
No back up fuse required.



# UL/CSA performance data (Motor protection)

Manual motor controller  
(UL 508, CSA C22.2 as Manual motor controllers)

● **GMS-32S**

Rated operational current I <sub>e</sub>	[A]	0.16	0.25	0.4	0.63	1	1.6	2.5	4	6	8	10	13	17	22	26	32	
<b>Max. short-circuit current</b>																		
240V	[kA]	100	100	100	100	100	100	100	100	100	100	50	50	40	30	30	20	
480Y/277V	[kA]	50	50	50	50	50	50	50	50	25	25	10	10	10	10	7.5	7.5	
600Y/347V	[kA]	10	10	10	10	10	10	10	5	5	5	5	5	5	5	5	5	
<b>Motor load</b>																		
1 Phase	115V	[HP]	-	-	-	-	-	-	1/8	1/4	1/3	1/2	1/2	1	2	2	2	
	230V	[HP]	-	-	-	-	-	1/10	1/6	1/3	3/4	1	1½	2	3	3	5	
3 Phase	230V	[HP]	-	-	-	-	-	1/3	1/2	1	1½	2	3	3	5	7½	7½	10
	460V	[HP]	-	-	-	-	1/2	3/4	1½	2	5	5	7½	7½	10	15	15	20
	575V	[HP]	-	-	-	-	1/2	1	1½	3	5	5	10	10	15	20	20	30
<b>Maximum rated current of fuse or breaker</b>		[A]	500	500	500	500	500	500	500	500	500	500	500	500	500	500	500	

Manual motor controller "group installation" or "Type E starter"  
(UL 508, CSA C22.2 No..14, for group installation, in connection with a short-circuit protection device)

● **GMS-32H**

Rated operational current I <sub>e</sub>	[A]	0.16	0.25	0.4	0.63	1	1.6	2.5	4	6	8	10	13	17	22	26	32	
<b>Max. short-circuit current</b>																		
240V	[kA]	100	100	100	100	100	100	100	100	100	100	100	100	100	100	100	100	
480Y/277V	[kA]	65	65	65	65	65	65	65	65	65	65	65	65	30	30	30	30	
600Y/347V	[kA]	25	25	25	25	25	25	25	25	25	25	25	25	10	10	10	10	
<b>Motor load</b>																		
1 Phase	115V	[HP]	-	-	-	-	-	-	1/8	1/4	1/3	1/2	1/2	1	2	2	2	
	230V	[HP]	-	-	-	-	-	1/10	1/6	1/3	3/4	1	1½	2	3	3	5	
3 Phase	230V	[HP]	-	-	-	-	-	1/3	1/2	1	1½	2	3	3	5	7½	7½	10
	460V	[HP]	-	-	-	-	1/2	3/4	1½	2	5	5	7½	7½	10	15	15	20
	575V	[HP]	-	-	-	-	1/2	1	1½	3	5	5	10	10	15	20	20	30
<b>Maximum rated current of fuse or breaker</b>		[A]	500	500	500	500	500	500	500	500	500	500	500	500	500	500	500	





# Technical Information

## UL/CSA performance data (Motor protection)

Manual motor controller "group installation" or "Type E starter"  
(UL 508, CSA C22.2 No.14, for group installation, in connection with a short-circuit protection device)



### ● GMS-63S

Rated operational current I <sub>e</sub>	[A]	10	13	17	22	26	32	40	50	63	
<b>Max. short-circuit current</b>											
240V	[kA]	100	100	100	100	100	100	100	100	100	
480Y/277V	[kA]	50	50	40	40	40	40	40	40	40	
600Y/347V	[kA]	10	10	10	10	10	10	10	10	10	
<b>Motor load</b>											
1 Phase	115V	[HP]	1/2	1/2	1	2	2	3	3	5	5
	230V	[HP]	1½	2	3	3	5	5	7½	10	15
3 Phase	230V	[HP]	3	3	5	7½	10	10	15	15	20
	460V	[HP]	7½	7½	10	15	20	25	30	40	50
	575V	[HP]	10	10	15	20	25	30	40	50	60
<b>Maximum rated current of fuse or breaker</b>		[A]	600	600	600	600	600	600	600	600	600



### ● GMS-63H

Rated operational current I <sub>e</sub>	[A]	10	13	17	22	26	32	40	50	63	
<b>Max. short-circuit current</b>											
240V	[kA]	100	100	100	100	100	100	100	100	100	
480Y/277V	[kA]	65	65	50	50	50	50	50	50	50	
600Y/347V	[kA]	25	25	10	10	10	10	10	10	10	
<b>Motor load</b>											
1 Phase	115V	[HP]	1/2	1/2	1	2	2	3	3	5	5
	230V	[HP]	1½	2	3	3	5	5	7½	10	15
3 Phase	230V	[HP]	3	3	5	7½	10	10	15	15	20
	460V	[HP]	7½	7½	10	15	20	25	30	40	50
	575V	[HP]	10	10	15	20	25	30	40	50	60
<b>Maximum rated current of fuse or breaker</b>		[A]	600	600	600	600	600	600	600	600	600

Manual motor controller "group installation" or "Type E starter"  
(UL 508, CSA C22.2 No..14, for group installation, in connection with a short-circuit protection device)

## ● GMS-100S



Rated operational current I <sub>e</sub> [A]			17	22	26	32	40	50	63	75	90	100
<b>Max. short-circuit current</b>												
	240V	[kA]	100	100	100	100	100	100	100	100	100	100
	480Y/277V	[kA]	50	50	50	50	50	50	40	40	40	40
	600Y/347V	[kA]	10	10	10	10	10	10	10	10	10	10
<b>Motor load</b>												
1 Phase	115V	[HP]	1	1½	2	3	3	5	5	7½	10	10
	230V	[HP]	3	3	5	5	7½	10	15	15	20	20
3 Phase	230V	[HP]	5	7½	10	10	15	15	20	25	30	40
	460V	[HP]	10	15	20	25	30	40	50	60	75	75
	575V	[HP]	15	20	25	30	40	50	60	75	100	100
<b>Maximum rated current of fuse or breaker</b>			[A]	1000	1000	1000	1000	1000	1000	1000	1000	1000

## ● GMS-100H



Rated operational current I <sub>e</sub> [A]			17	22	26	32	40	50	63	75	90	100
<b>Max. short-circuit current</b>												
	240V	[kA]	100	100	100	100	100	100	100	100	100	100
	480Y/277V	[kA]	65	65	65	65	65	65	50	50	50	50
	600Y/347V	[kA]	25	20	20	20	20	20	10	10	10	10
<b>Motor load</b>												
1 Phase	115V	[HP]	1	1½	2	3	3	5	5	7½	10	10
	230V	[HP]	3	3	5	5	7½	10	15	15	20	20
3 Phase	230V	[HP]	5	7½	10	10	15	15	20	25	30	40
	460V	[HP]	10	15	20	25	30	40	50	60	75	75
	575V	[HP]	15	20	25	30	40	50	60	75	100	100
<b>Maximum rated current of fuse or breaker</b>			[A]	1000	1000	1000	1000	1000	1000	1000	1000	1000

# Technical Information

## Manual Motor Controller (UL508)

### ● GMS-32S

Rated operational current I <sub>e</sub>	[A]	0.16	0.25	0.4	0.63	1	1.6	2.5	4	6	8	10	13	17	22	26	32	
<b>Max. short-circuit current</b>																		
240V	[kA]	100	100	100	100	100	100	100	100	100	100	50	50	40	30	30	20	
480Y/277V	[kA]	50	50	50	50	50	50	50	50	25	25	10	10	10	10	7.5	7.5	
600Y/347V	[kA]	10	10	10	10	10	10	10	5	5	5	5	5	5	5	5	5	
<b>Motor load</b>																		
1 Phase	115V	[HP]	-	-	-	-	-	-	1/8	1/4	1/3	1/2	1/2	1	2	2	2	
	230V	[HP]	-	-	-	-	-	1/10	1/6	1/3	3/4	1	1½	2	3	3	5	
3 Phase	230V	[HP]	-	-	-	-	-	1/3	1/2	1	1½	2	3	3	5	7½	7½	10
	460V	[HP]	-	-	-	-	1/2	3/4	1½	2	5	5	7½	7½	10	15	15	20
	575V	[HP]	-	-	-	-	1/2	1	1½	3	5	5	10	10	15	20	20	30
<b>Max. fuse size</b>	[A]	1	1	1	1	3	6	10	15	20	30	40	50	60	80	100	125	
<b>Max. breaker size</b>	[A]	15	15	15	15	15	15	15	15	20	30	40	50	60	80	100	125	

### ● GMS-32H

Rated operational current I <sub>e</sub>	[A]	0.16	0.25	0.4	0.63	1	1.6	2.5	4	6	8	10	13	17	22	26	32	
<b>Max. short-circuit current</b>																		
240V	[kA]	100	100	100	100	100	100	100	100	100	100	100	100	100	100	100	100	
480Y/277V	[kA]	50	50	50	50	50	50	50	50	50	50	50	50	30	30	30	30	
600Y/347V	[kA]	10	10	10	10	10	10	10	10	10	10	10	10	10	10	10	10	
<b>Motor load</b>																		
1 Phase	115V	[HP]	-	-	-	-	-	-	1/8	1/4	1/3	1/2	1/2	1	2	2	2	
	230V	[HP]	-	-	-	-	-	1/10	1/6	1/3	3/4	1	1½	2	3	3	5	
3 Phase	230V	[HP]	-	-	-	-	-	1/3	1/2	1	1½	2	3	3	5	7½	7½	10
	460V	[HP]	-	-	-	-	1/2	3/4	1½	2	5	5	7½	7½	10	15	15	20
	575V	[HP]	-	-	-	-	1/2	1	1½	3	5	5	10	10	15	20	20	30
<b>Max. fuse size</b>	[A]	1	1	1	1	3	6	10	15	20	30	40	50	60	80	100	125	
<b>Max. breaker size</b>	[A]	15	15	15	15	15	15	15	15	20	30	40	50	60	80	100	125	

### ● GMS-63S

Rated operational current I <sub>e</sub>	[A]	10	13	17	22	26	32	40	50	63	
<b>Max. short-circuit current</b>											
240V	[kA]	100	100	100	100	100	100	100	100	100	
480Y/277V	[kA]	25	25	25	25	25	25	25	25	25	
600Y/347V	[kA]	10	10	10	10	10	10	10	10	10	
<b>Motor load</b>											
1 Phase	115V	[HP]	1/2	1/2	1	2	2	3	3	5	5
	230V	[HP]	1½	2	3	3	5	5	7½	10	15
3 Phase	230V	[HP]	3	3	5	7½	10	10	15	15	20
	460V	[HP]	7½	7½	10	15	20	25	30	40	50
	575V	[HP]	10	10	15	20	25	30	40	50	60
<b>Max. fuse size</b>	[A]	40	50	60	80	100	125	150	200	250	
<b>Max. breaker size</b>	[A]	40	50	60	80	100	125	150	200	250	



## ● GMS-63H

Rated operational current I <sub>e</sub>		[A]	10	13	17	22	26	32	40	50	63
<b>Max. short-circuit current</b>											
	240V	[kA]	100	100	100	100	100	100	100	100	100
	480Y/277V	[kA]	50	50	50	50	50	50	50	50	50
	600Y/347V	[kA]	10	10	10	10	10	10	10	10	10
<b>Motor load</b>											
1 Phase	115V	[HP]	1/2	1/2	1	2	2	3	3	5	5
	230V	[HP]	1½	2	3	3	5	5	7½	10	15
3 Phase	230V	[HP]	3	3	5	7½	10	10	15	15	20
	460V	[HP]	7½	7½	10	15	20	25	30	40	50
	575V	[HP]	10	10	15	20	25	30	40	50	60
<b>Max. fuse size</b>		[A]	40	50	60	80	100	125	150	200	250
<b>Max. breaker size</b>		[A]	40	50	60	80	100	125	150	200	250



## ● GMS-100S

Rated operational current I <sub>e</sub>		[A]	17	22	26	32	40	50	63	75	90	100
<b>Max. short-circuit current</b>												
	240V	[kA]	100	100	100	100	100	100	100	100	100	100
	480Y/277V	[kA]	25	25	25	25	25	25	25	25	25	25
	600Y/347V	[kA]	10	10	10	10	10	10	10	10	10	10
<b>Motor load</b>												
1 Phase	115V	[HP]	1	1½	2	3	3	5	5	7½	10	10
	230V	[HP]	3	3	5	5	7½	10	15	15	20	20
3 Phase	230V	[HP]	5	7½	10	10	15	15	20	25	30	40
	460V	[HP]	10	15	20	25	30	40	50	60	75	75
	575V	[HP]	15	20	25	30	40	50	60	75	100	100
<b>Max. fuse size</b>		[A]	60	80	100	125	150	200	250	300	350	400
<b>Max. breaker size</b>		[A]	60	80	100	125	150	200	250	300	350	400



## ● GMS-100H

Rated operational current I <sub>e</sub>		[A]	17	22	26	32	40	50	63	75	90	100
<b>Max. short-circuit current</b>												
	240V	[kA]	100	100	100	100	100	100	100	100	100	100
	480Y/277V	[kA]	50	50	50	50	50	50	50	50	50	50
	600Y/347V	[kA]	10	10	10	10	10	10	10	10	10	10
<b>Motor load</b>												
1 Phase	115V	[HP]	1	1½	2	3	3	5	5	7½	10	10
	230V	[HP]	3	3	5	5	7½	10	15	15	20	20
3 Phase	230V	[HP]	5	7½	10	10	15	15	20	25	30	40
	460V	[HP]	10	15	20	25	30	40	50	60	75	75
	575V	[HP]	15	20	25	30	40	50	60	75	100	100
<b>Max. fuse size</b>		[A]	60	80	100	125	150	200	250	300	350	400
<b>Max. breaker size</b>		[A]	60	80	100	125	150	200	250	300	350	400

# Technical Information

## General data



Type		GMS-32S
<b>Rated insulation voltage</b>		
	IEC	690V
	UL, CSA	600V
<b>Rated impulse withstand voltage</b>		
Uimp/Pollution degree		6kV / 3
<b>Rated frequency</b>		50 / 60 Hz
<b>Utilization category:</b>		
IEC 947-2 (Circuit breaker)		Cat. A
IEC 947-4-1 (Motor starter)		AC 3
<b>Life span</b>		
Mechanical	Operations	100,000
Electrical(Ie max.)	Operations	100,000
<b>Switching frequency</b>		Ope./h
		25
<b>Ambient temperature</b>		
	Storage	°C
		-50 ~ +80
	Operation	°C
		-20 ~ +60
<b>Operation altitude</b>		m
		Up to 2000 (6500 Feet)
<b>Protection class</b>		IP 20
		Safe from finger touch
<b>Resistance to shock</b>		g
		25
<b>Resistance to vibration</b>		Hz
		5 ~ 150
<b>Rated thermal current Ith</b>		
IEC	[A]	0.1 ... 32
up to 60°C ambient temperature		
<b>Overload protection</b>		
Characteristics		○
<b>Ambient temperature compensation, thermal current Ith adjustments</b>		
	-20°C ~ -5°C	set one point lower <sup>3)</sup>
	-5°C ~ +40°C	automatic
	+40°C ~ +60°C	set one point higher <sup>3)</sup>
<b>Phase-failure protection</b>		○
<b>Trip class</b>		IEC 60947-4-1
		10
<b>Magnetic release</b>		
Response current		13 × In <sup>2)</sup>
<b>Total power loss Pv</b>		
Circuit breaker at rated load	[W]	In = 0.16~4A : 9.8
Operating temperature		In = 6~26A : 8
		In = 32A : 3.9

Note = 1) Class20; GMS-63HL, GMS-100HL





2) In = Max. rated operational current Ie

3) use Thermal Current dial to adjust accordingly



	GMS-32H	GMS-63S, 63H	GMS-100S, 100H
	690V	1000V	1000V
	600V	600V	600V
	6kV / 3	8kV / 3	8kV / 3
	50 / 60 Hz	50 / 60 Hz	50 / 60 Hz
	Cat. A	Cat. A	Cat. A
	AC 3	AC 3	AC 3
	100,000	50,000	50,000
	100,000	25,000	25,000
	25	25	25
	-50 ~ +80	-50 ~ +80	-50 ~ +80
	-20 ~ +60	-20 ~ +60	-20 ~ +60
	Up to 2000 (6500 Feet)	Up to 2000 (6500 Feet)	Up to 2000 (6500 Feet)
	IP 20	IP 20	IP 20
	Safe from finger touch	Safe from finger touch	Safe from finger touch
	25	25	25
	5 ~ 150	5 ~ 150	5 ~ 150
	0.1 ... 32	6 ... 63	11 ... 100
	<input type="radio"/>	<input type="radio"/>	<input type="radio"/>
	set one point lower <sup>3)</sup> automatic set one point higher <sup>3)</sup>	set one point lower <sup>3)</sup> automatic set one point higher <sup>3)</sup>	set one point lower <sup>3)</sup> automatic set one point higher <sup>3)</sup>
	<input type="radio"/>	<input type="radio"/>	<input type="radio"/>
	10	10 <sup>1)</sup>	10 <sup>1)</sup>
	13 × In <sup>2)</sup>	13 × In <sup>2)</sup>	13 × In <sup>2)</sup>
	In = 0.16~4A : 9.8 In = 6~26A : 8 In = 32A : 3.9	In = 10~22A : 13.3 In = 26~63A : 12.6	In = 17~63A : 11.9 In = 75~100A : 15

### ● Manual Motor Starter GMS-32...100

	GMS-32S	GMS-32H	GMS-32S, 63H	GMS-100S, 100H
<b>Conformity to standards</b>	IEC60947 UL508, UL508 Type E			
<b>Approvals</b>	CE, UL			
<b>Terminal parts</b>				
Screwdriver				
Single-core 1.conductor [mm] / [AWG]	1...10 / 18...8	1...10 / 18...8	0.75...35 / 18...2	2.5...70 / 12...2/0
2.conductor [mm] / [AWG]	1...6 / 18...10	1...6 / 18...10	0.75...25 / 18...4	2.5...50 / 12...1/0
Stranded 1.conductor [mm] / [AWG]	1...6 / 18...10	1...6 / 18...10	0.75...35 / 18...2	2.5...70 / 12...2/0
2.conductor [mm] / [AWG]	1...6 / 18...10	1...6 / 18...10	0.75...25 / 18...4	2.5...50 / 12...1/0
Flexible 1.conductor [mm] / [AWG]	1...6 / 18...10	1...6 / 18...10	0.75...25 / 18...4	2.5...50 / 12...1/0
2.conductor [mm] / [AWG]	0.75...4 / 18...10	0.75...4 / 18...10	0.75...16 / 18...6	2.5...35 / 10...2
Tightening torque [Nm] / [lb-in]	0.8...2.5 / 7...22	0.8...2.5 / 7...22	3...4.5 / 26...39	4...6 / 35...53

### ● Accessories for Manual Motor Starter GMS-32...100

	Auxiliary contacts for front mounting GFX...	Auxiliary contacts for left side mounting GSX...	Alarm switch for left side mounting GSA...
<b>Rated thermal current / th</b>			
at 40 °C ambient temperature [A]	5	1 0	1 0
at 60 °C ambient temperature [A]	3	6	6
<b>Contact class coordination according to NEMA (UL/CSA-Standards)</b>			
AC	B 600 Standard Pilot Duty	A 600 Standard Pilot Duty	A 600 Standard Pilot Duty
DC	R 300 Light Pilot Duty	Q 300 Light Pilot Duty	Q 300 Light Pilot Duty
<b>Back-up fuses gG, gL</b> [A]	16	1 6	1 6
<b>Rated supply current</b> [V]	24 240	24 240	24 240
AC-15: [A]	3 2	6 4	6 4
DC-13: [V]	24 220	24 220	24 220
[A]	1 0.1	2 0.25	2 0.25
<b>Terminal parts</b>			
Type of terminals		Pozidriv size 2	
Screwdriver			
Single-core 1.conductor [mm] / [AWG]		0.5...2.5 / 20...14	
2.conductor [mm] / [AWG]		0.5...2.5 / 20...14	
Flexible 1.conductor [mm] / [AWG]		0.5...4 / 20...10	
2.conductor [mm] / [AWG]		0.75...2.5 / 18...14	
<b>Tightening torque</b> [Nm] / [lb-in]		0.8...1.2 / 7...10	

## ● Accessories for Manual Motor Starter GMS-32...100

	Undervoltage release for right side mounting <b>GUR...</b>	Undervoltage release with 2 auxiliary contacts for right side mounting <b>GURX...</b>	Shunt release for right side mounting <b>GSR...</b>
<b>Actuating voltage</b>			
Pull-in	0.85...1.1 × Us	0.85...1.1 × Us	0.7...1.1 × Us
Drop-out	0.7...0.35 × Us	0.7...0.35 × Us	
<b>Rated control voltage</b>			
min.:	24V 50Hz / 28V 60Hz	24V 50Hz / 28V 60Hz	24V 50Hz / 28V 60Hz
max.:	415~440V 50Hz / 460~480V 60Hz	415~440V 50Hz / 460~480V 60Hz	415~440V 50Hz / 460~480V 60Hz
<b>Coil rating</b>			
Pull-in	8.5VA, 6W	8.5VA, 6W	8.5VA, 6W
Hold	3VA, 1.2W	3VA, 1.2W	3VA, 1.2W
On-Time	100%	100%	100%
<b>Terminal parts</b>			
Type of terminals			
Screwdriver		Pozidriv size 2	
1.conductor [mm] / [AWG]		0.5...2.5 / 20...14	
2.conductor [mm] / [AWG]		0.5...2.5 / 20...14	
1.conductor [mm] / [AWG]		0.5...4 / 20...10	
2.conductor [mm] / [AWG]		0.75...2.5 / 18...14	
<b>Tightening torque</b> [Nm] / [lb-in]		0.8...1.2 / 7...10	

## ● Weights

Description	Type	Weight [g]
<b>Circuit breaker</b>	<b>GMS-32S</b>	320
	<b>GMS-32H</b>	360
	<b>GMS-63S</b>	1,000
	<b>GMS-100S</b>	2,200
<b>Auxiliary switch</b>	<b>GFX...</b> (Front Auxiliary Switch)	18
	<b>GSX...</b> (Side Auxiliary Switch)	30
	<b>GSA...</b> (Alarm Switch)	40
<b>Undervoltage release</b>	<b>GUR...</b> (Undervoltage release)	110
	<b>GURX...</b> (Undervoltage release with 2 auxiliary contacts)	120
<b>Shunt release</b>	<b>GSR...</b> (Shunt release)	110



## Type '2' coordination according to IEC 947-4-1

- Short-circuit current  $I_q = 50\text{kA}$   
Voltage : 400/415V, 50/60Hz

Standard motors AC-3 at 400/415V 1500rpm		Manual motor starter			Contactor	
[kW]	[A]	Circuit breaker Type	Thermal overload release setting range [A]	Magnetic release response current [A]	Type	[A]
0.06	0.24	GMS-32S 0.25A	0.16 ~0.25	3.25	CGMS-6	6
0.09	0.33	GMS-32S 0.4A	0.25~0.4	5.2	CGMS-6	6
0.12	0.43	GMS-32S 0.63A	0.4~0.63	8.19	CGMS-6	6
0.18	0.61	GMS-32S 0.63A	0.4~0.63	8.19	CGMS-6	6
0.25	0.8	GMS-32S 1A	0.63~1	13	CGMS-6	6
0.37	1.1	GMS-32S 1.6A	1~1.6	20.8	CGMS-6	6
0.55	1.5	GMS-32S 1.6A	1~1.6	20.8	CGMS-6	6
0.75	1.9	GMS-32S 2.5A	1.6~2.5	32.5	CGMS-9/CGC-9	9
1.1	2.7	GMS-32S 4A	2.5~4	52	CGMS-9/CGC-9	9
1.5	3.5	GMS-32S 4A	2.5~4	52	CGMS-12/CGC-12	12
2.2	5.0	GMS-32S 6A	4~6	78	CGC-18	18
3.0	6.6	GMS-32S 8A	5~8	104	CGC-18	18
4.0	8.5	GMS-32S 10A	6~10	130	CGC-18	18
5.5	11.0	GMS-32S 13A	9~13	169	CGC-22	22
7.5	15.0	GMS-32H 17A	11~17	221	CGC-22	22
10.0	20.0	GMS-32H 22A	14~22	286	CGC-32	32
11.0	22.0	GMS-32H 26A	18~26	338	CGC-32	32
15.0	29.0	GMS-32H 32A	22~32	416	CGC-32	32
18.5	36.0	GMS-63S 40A	28~40	520	CGC-50	50
22.0	41.0	GMS-63S 50A	34~50	650	CGC-50	50
30.0	56.0	GMS-63S 63A	45~63	819	CGC-65	65
37.0	68.0	GMS-100S 75A	55~75	975	CGC-75	75
-	-	GMS-100S 90A	70~90	1170	CGC-85	85
45.0	81.0	GMS-100S 100A	80~100	1300	CGC-85	85

### Definition type '2' coordination according to IEC 947-4-1

- The contactor or the starter must not endanger persons or systems in the event of a short-circuit.
- The contactor or the starter must be suitable for further use.
- No damage to the overload relay or other parts may occur with the exception of welding of the contactor or starter contacts provided that these can be easily separated without significant deformation (such as with a screwdriver).

# Time/Current characteristic

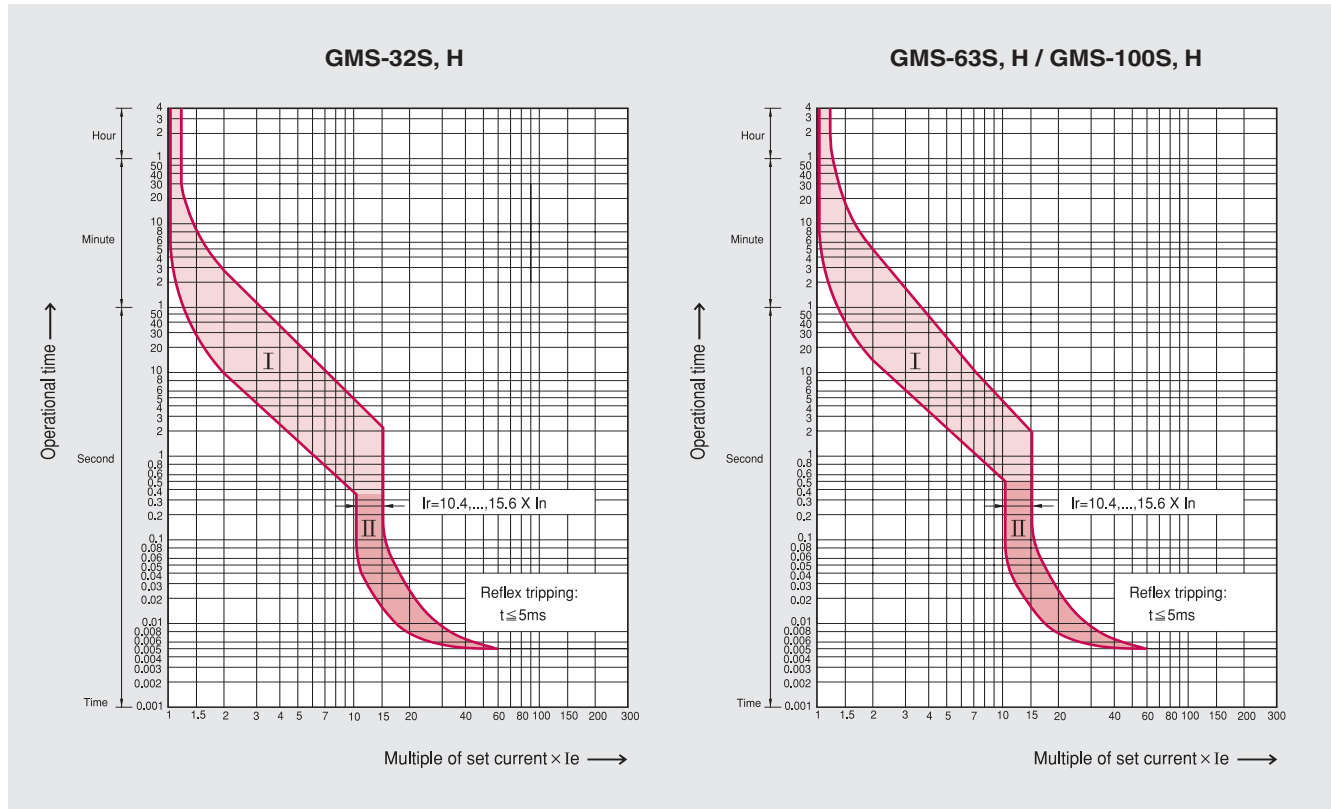

## I ) Thermal release trip current :

The adjustable inverse bimetal trip reliability protects motors against overloads.  
The curve shows the mean operating current at an ambient temperature of 20 °C starting from cold.  
Careful testing and setting ensures effective motor protection even in the case of single-phasing.

## II ) Magnetic release trip current :

The instantaneous magnetic trip has a fixed operating current setting.  
This corresponds to 13times the maximum value of setting range,  
at a lower setting it is correspondingly higher.

## Current setting Ie :

The overload trip corresponds to a thermal overload relay in a motor starter conforming to IEC 947-4-1.  
If a different value is prescribed (e.g. reduced Ie for cooling medium having a temperature higher than 40 °C or a place of installation higher than 2000m above sea level),  
the setting current is equal to the reduced rated current Ie of the motor.

### ● GMS-32S

[mm]

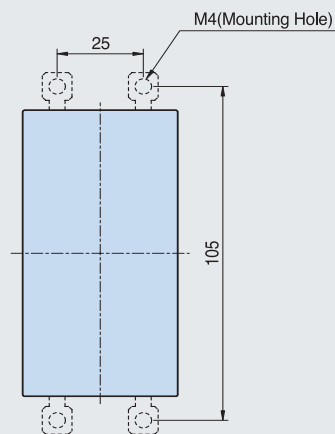
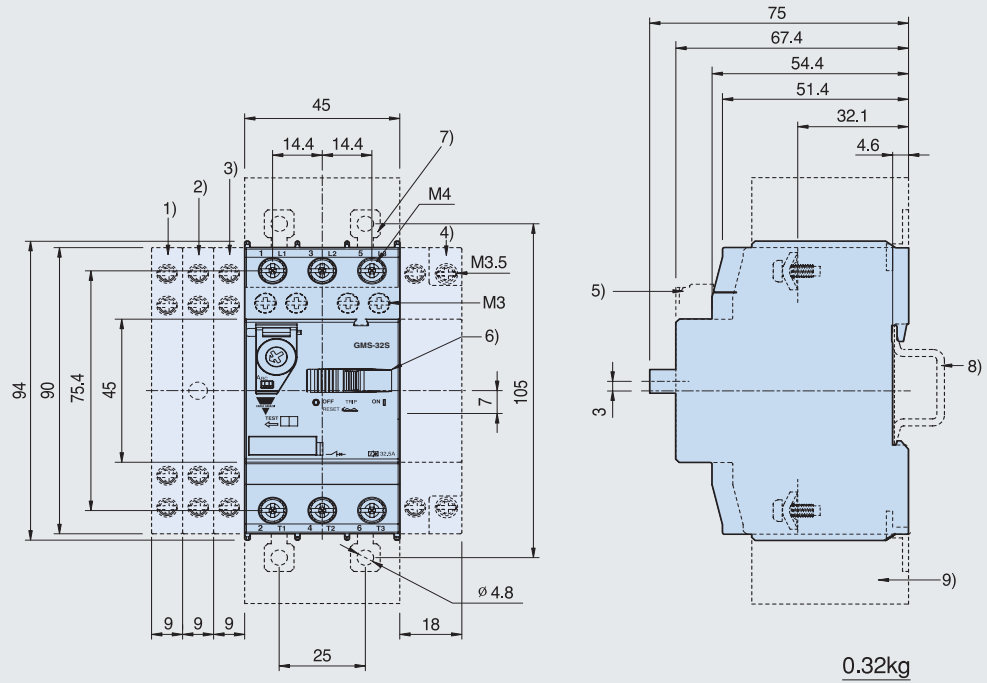

- 1) Side auxiliary switch
- 2) Side magnetic trip alarm switch
- 3) Side any trip alarm switch
- 4) Side shunt release or Side undervoltage release
- 5) Front auxiliary switch
- 6) Handle lock in OFF position(  $\varnothing$  5mm)
- 7) Push-in Lugs for screw mounting
- 8) 35mm standard mounting rail acc. to EN 50 022
- 9) Arcing space

Height of arcing spaces  
(Clearance from earthed parts)

Ue[V]	240	415	460	525	690
[mm]	20	20	20	20	20

Arcing spaces for limiter function

Ue[V]	525		690	
	left/right	top/bottom	left/right	top/bottom
[mm]	10	40	30	50

## ● GMS-32H, 32HI

[mm]

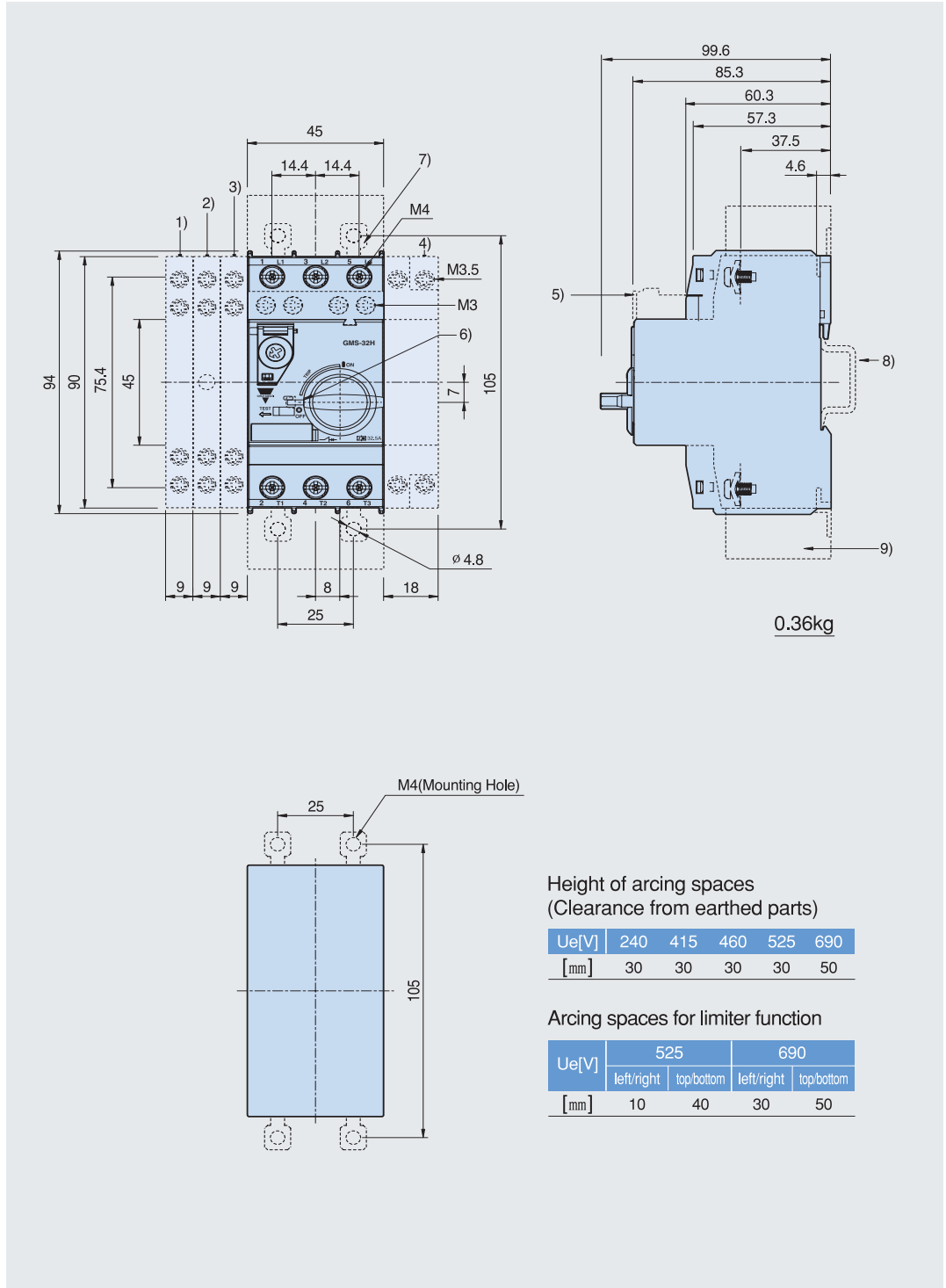

● GMS-63S, 63H, 63HI, 63HL

[mm]

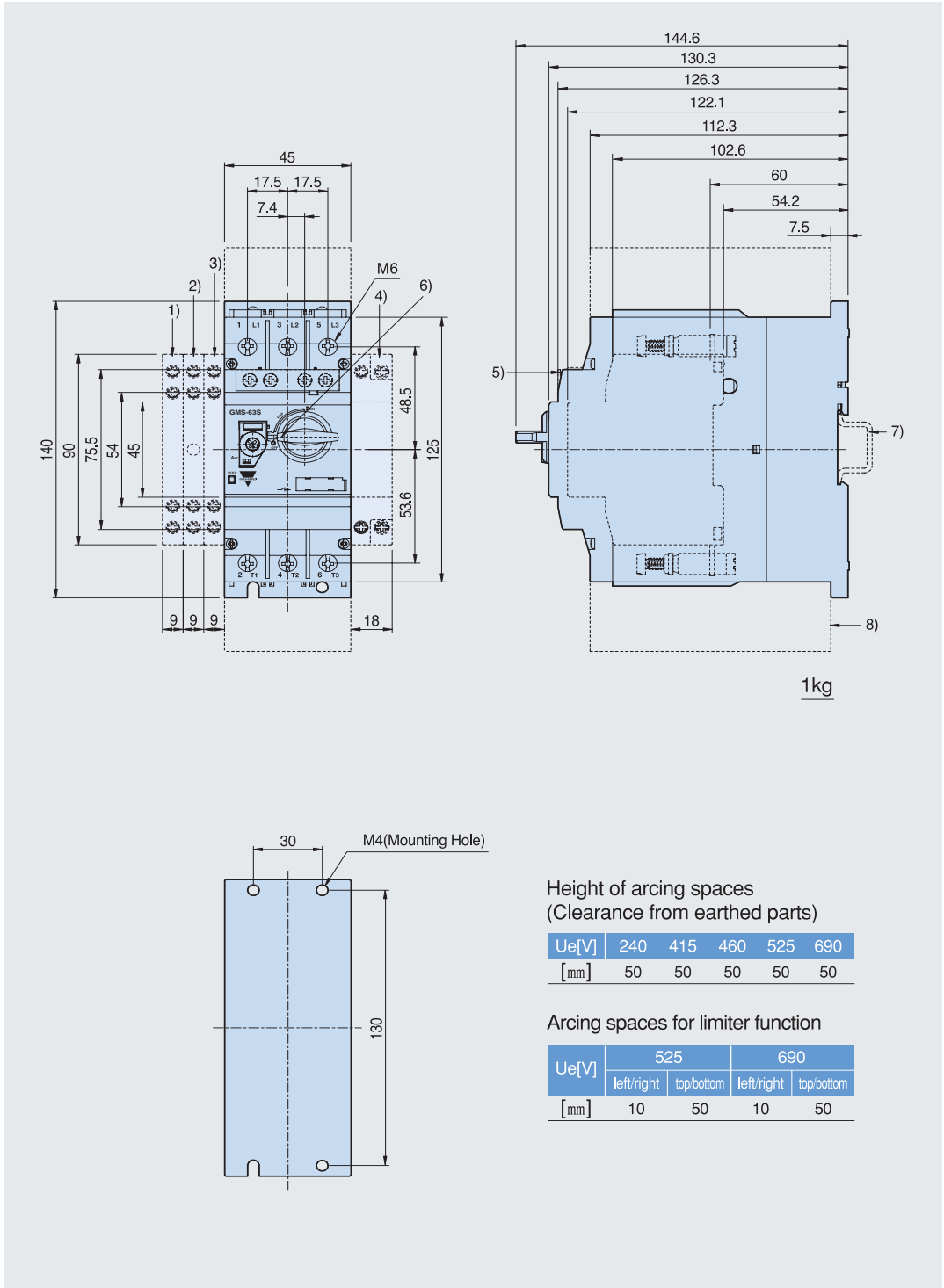

- 1) Side auxiliary switch
- 2) Side magnetic trip alarm switch
- 3) Side any trip alarm switch
- 4) Side shunt release or Side undervoltage release
- 5) Front auxiliary switch
- 6) Handle lock in OFF position (∅ 5mm)
- 7) 35mm standard mounting rail acc. to EN 50 022
- 8) Arcing space

## ● GMS-100S, 100H, 100HI, 100HL

[mm]

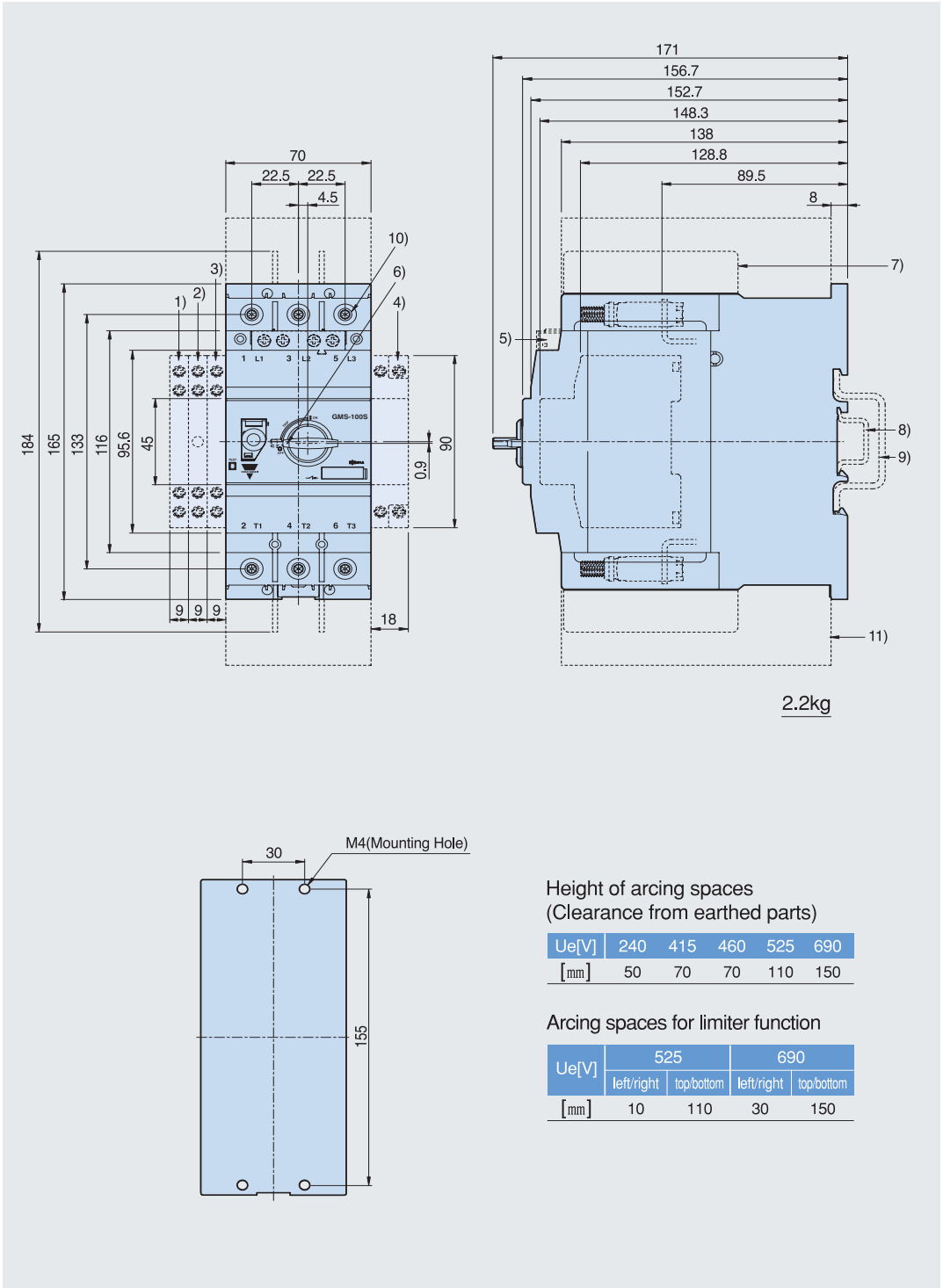

- 1) Side auxiliary switch
- 2) Side magnetic trip alarm switch
- 3) Side any trip alarm switch
- 4) Side shunt release or Side undervoltage release
- 5) Front auxiliary switch
- 6) Handle lock in OFF position (ø 5mm)
- 7) Insulation barrier
- 8) 35mm standard mounting rail acc. to EN 50 022
- 9) 75mm standard mounting rail acc. to EN 50 023
- 10) 4mm hexagon socket screw
- 11) Arcing space

# Notes:





# www.GavazziOnline.com

www.GavazziOnline.com is an information filled website which offers you the ability to download data sheets, specify products, check pricing and availability, track shipping and so much more:



Download Brochures



Easy-to-use Product Selection Guides



New Product Press Releases



Industry Specific Brochures/Flyers



Latest Events



Data Sheets



Industry Specific Web Pages

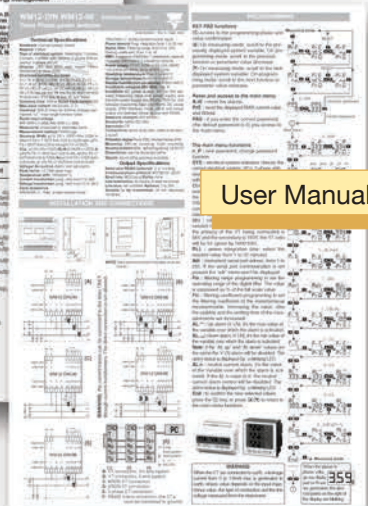

User Manuals